

MR HORACE SMITH
SMITHS RADIO & TV
850 LAURELWOOD ROAD
POTTSTOWN PA 19464

May, 1976 □ 75 cents

Electronic Servicing



A HOWARD W. SAMS PUBLICATION

STROBE TUNING OF MUSICAL INSTRUMENTS

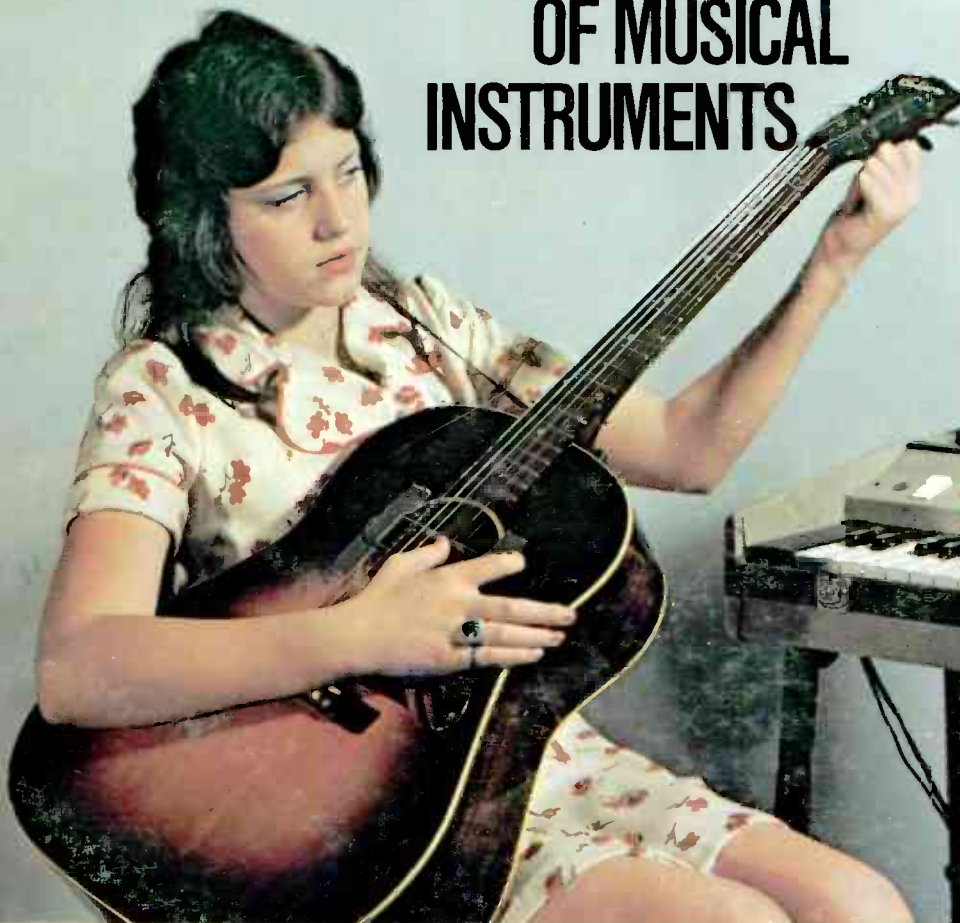

Wide-Band Scope For CB

Servicing XL-100

Selecting CB Antennas

GIVE YOUR OLD MODULES



At PTS getting another chance means module rebuilding or exchanging at the lowest possible cost. Compare our prices to anyone else's. Another chance also means quality work in the least amount of time and our one year warranty. In addition to rebuilding, buying and exchanging modules we maintain an extensive inventory of replacement modules.

**Module Rebuilding
\$5.95 Up**

ANOTHER CHANCE

PTS—FIRST IN TUNER SERVICE IS
NOW FIRST IN MODULE REBUILDING
PTS HAS COMPANY-OWNED SERVICE CENTERS
THROUGHOUT THE U.S. AND CANADA.



ELECTRONICS, INC.

PRECISION TUNER SERVICE

Consult the white pages of your telephone directory for the address and number of your nearest PTS Service Center. General Headquarters: Bloomington, IN - Birmingham - Phoenix - Los Angeles - San Diego - San Jose (CA) - Sacramento - Arvada (CO) - Jacksonville - Tampa - Indianapolis - Kansas City (KS) - Metairie (LA) - Silver Spring (MD) - Boston - Springfield (MA) - Detroit - Grand Rapids (MI) - Minneapolis - St. Louis - E. Paterson (NJ) - Buffalo (NY) - Long Island - Charlotte (NC) - Cincinnati - Columbus (OH) - Cleveland - Oklahoma City - Portland (OR) - Pittsburgh - Philadelphia - Montreal - Memphis - Houston - Longview (TX) - Salt Lake City - Norfolk - Seattle - Milwaukee.

For More Details Circle (2) on Reply Card

When you install a B-T Booster outside, you get a lot of new boosters inside.

The service technician's job is a tough one. Customers are always grumbling about the high cost of TV service calls. And they complain about poor reception—even when it's almost impossible to get a good signal.

But now and then a TV service technician wins one. And one of the products that can make him a winner, and create customer goodwill, is a Blonder-Tongue outdoor booster.

B-T Boosters can produce a dramatic improvement in picture quality, particularly on color and especially in difficult reception areas. After 25 years of making outdoor boosters, B-T is number one in sales, and enjoys the finest reputation for making

products of highest performance and reliability. B-T Boosters do cost a bit more than competition, but they perform and last longer. And that's what makes satisfied customers.

The VAULTER, for example, is the number one outdoor booster today in the B-T line... *and* in the entire industry. This ultra-high performance, all-channel amplifier offers the ideal combination of lowest possible noise figure (4.6dB, VHF; 7.0dB, UHF) and high gain (15dB). While it can't make unusable, snowy pictures perfect, it *can* reduce fading, loss of color, overcome cable loss and reduce lead-in cable noise. It can even feed more than one TV set from the same antenna in fringe reception areas. It

has separate U/V inputs and a coax output. Finally, it's specially designed for lightning prone areas.

The B-T line consists of 5 all-channel models (including the popular VOYAGER); 5 VHF models and 4 UHF boosters (the ABLE-U2b is a favorite).

See your B-T distributor for details. And see why you can count on boosters inside, when you install B-T Boosters outside. Blonder-Tongue Laboratories, Inc., One Jake Brown Road, Old Bridge, N.J. 08857.



BLONDER-TONGUE



For More Details Circle (4) on Reply Card

Electronic Servicing

in this issue...

- 12 **Reports From The Test Lab**—Basic information about tuning musical instruments is given, and how to use the Strobotuner to tune them perfectly—*Carl Babcoke, CET.*
- 18 **Planning A New Service Business...Or Revitalizing An Old One, Part 1**—This good advice starts with questions you should ask yourself, and includes suggestions for business planning—*Small Business Administration.*
- 24 **Scoping CB Carriers**—New Tektronix scopes can show 27-MHz carriers, thus greatly helping the accuracy and speed of CB repairs—*Marvin J. Beasley, CET.*
- 30 **Servicing RCA XL-100, Part 7**—Many important testpoints are shown, plus video and chroma waveforms to guide your troubleshooting—*Gill Grieshaber, CET.*
- 42 **How To Select And Install CB Mobile Antennas**—Location of the antenna on the car affects the radiation pattern, and different types are required for these locations—*David E. Hicks.*
- 48 **Tremendous Trifles...The Nitty-Gritty Of Servicing**—Electronic theory and expensive test equipment are no more important than making solid test connections in small spaces, desoldering without board damage, and the technique of soldering correctly—*Carl Babcoke.*

ABOUT THE COVER

Rhonda Casper shows how to tune a guitar, using a Conn Strobotuner as the frequency standard. Rhonda is a granddaughter of Editor Carl Babcoke.

DEPARTMENTS

Electronic Scanner	4	Book Review	53
Symcure	8	Product Report	54
Troubleshooting Tips	9	Test Equipment	55
Reader's Exchange	10	Photofact	57
		Advertiser's Index	58

Second class postage paid at Shawnee Mission, Kansas and additional mailing offices. Published monthly at 9221 Quivira Road, Shawnee Mission, Kansas 66215 by Intertec Publishing Corp., 1014 Wyandotte St., Kansas City, Mo. 64105. Send Form 3579 to 9221 Quivira Road, Shawnee Mission, Ks. 66215.

© Copyright, 1976, Howard W. Sams & Co., Inc. All rights reserved. Material may not be reproduced or photocopied in any form without written permission of publisher.

EDITORIAL
RONALD N. MERRELL, Director
CARL H. BABCOKE, Managing Editor
SHARON ELWOOD, Editorial Assistant
DUDLEY ROSE, Graphic Designer

ELECTRONIC SERVICING
1014 Wyandotte Street
Kansas City, Missouri 64105
Tele: 913/888-4664

TECHNICAL CONSULTANT
JOE A. GROVES

EDITORIAL ADVISORY BOARD
LES NELSON, Chairman
Howard W. Sams & Co., Indianapolis

CIRCULATION
EVELYN ROGERS, Manager

ADVERTISING SALES
Kansas City, Missouri 64105
Tele: 913/888-4664
MIKE KREITER, Director
GLORIA PARMENTER, Production

REGIONAL ADVERTISING SALES OFFICES
Indianapolis, Indiana 46280
ROY HENRY
2469 E. 98th St.
Tele: 317/846-7026

Greenlawn, New York 11748
CHARLES C. HORNER
P.O. Box 175
Tele: (516) 757-8868

Mountain View, California 94043
DENNIS TRIOLA
2680 Bayshore Frontage Road, Room 102
Tele: 415/961-0378

London W.C. 2, England
JOHN ASHCRAFT & CO.
12 Bear Street
Leicester Square
Tele: 930-0525

Badhoevedorp, Holland
John Ashcraft & Co.,
John J. Lucassen, Mgr.
Sloterweg 303
Tele: 2968-6226.

Tokyo, Japan
INTERNATIONAL MEDIA
REPRESENTATIVES LTD.
1, Shiba-Kotohiracho, Minatoku
Tele: 502-0656



ELECTRONIC SERVICING (with which is combined PF Reporter) is published monthly by Intertec Publishing Corp., 1014 Wyandotte Street, Kansas City, Missouri 64105.

Subscription Prices: 1 year — \$6.00, 2 years — \$10.00, 3 years — \$13.00, in the U.S.A. and its possessions.

All other foreign countries: 1 year — \$7.00, 2 years — \$12.00, 3 years — \$16.00. Single copy 75c; back copies \$1. Adjustment necessitated by subscription termination to single copy rate.

 Robert E. Hertel, Publisher
INTERTEC PUBLISHING CORP.
Subsidiary of HOWARD W. SAMS & CO., INC.

In receiving tubes, the only full line is now our line.

Sylvania makes the broadest line of receiving tubes in the world—from Nuvistor to power tubes.

And we sell more of them in the U.S. than anyone else.

That means your best bet for all tube needs is your local Sylvania full-line distributor. He's part of the largest distributor network devoted to electronic components.

He carries the most complete line available and he also has our line of business builder ad mats, service aids, signs and displays—plus tube caddies to make your job easier.

And don't forget, every Sylvania tube you buy gives you another point towards a bigger premium in our "rally 'round the tab!" award program.

For the most complete line of tubes and complete information on other Sylvania services, see your local distributor today.

GTE SYLVANIA

GTE Sylvania, Electronic Components Group, 100 First Ave., Waltham, MA. 02154

electronicscanner

news of the industry

A biofeedback machine smaller than a human hand has been developed by Thought Technology of Montreal, Canada. On top of the device are two grooves where the tips of index and third finger are placed. After adjustment of the tone-control wheel on the side, the pitch of a tone emitted by the Model GSR-1 machine varies according to a person's inner level of tension or relaxation. According to *Canada Courier*, the idea is to reduce the pitch of the tone in an effort to become more relaxed. It has proven to be of value in the treatment of insomnia, phobias, hypertension, and other stress-related illnesses.

Sony Corporation has developed a new Trinitron color picture tube with a diagonal picture size of 32.2 inches, according to *Home Furnishings Daily*. A deluxe console and a monitor using the tube will be sold in Japan starting this fall. Price of the console is expected to be around \$5,000, with an electronic tuner, a video terminal (for tape player), and a two-way speaker system. Sony expects a heavy demand for the sets, when they are introduced on the American market.

There are more questions than answers about the expansion of the CB band. The FCC has said that interference problems are delaying decisions, but now has given January 1, 1977 as the expected date for expanding the channels. Present plans call for an increase from 23 to around 100 channels, with half of them for single-sideband transmission. However, some of the new channels are likely to be using frequencies far removed from 27 MHz; perhaps UHF, or part of amateur bands which are not crowded.

GTE-Sylvania has purchased tube-building machinery, parts, raw materials and technical data from RCA. The RCA tube plant in Harrison, New Jersey has been closed. It has been said that Sylvania plans to manufacture 50 to 60 types of tubes (including the Nuvistor) formerly produced by RCA.

Capehart has announced the cancelling of a \$3.8-million contract with J. C. Penney, and the negotiations of a \$20-million order from K-Mart. Capehart manufactures stereo products.

A meeting of seven electronics industry associations attracted 35 persons recently in Seattle, Washington. The meeting was for the purpose of discussing common problems, such as how to keep an association advancing, the contribution of the annual conventions, results from the apprenticeship programs, and publishing associational magazines. A similar conference is planned for May 21-23 in Norfolk, Virginia by the "Eastern Electronics Associations Conference". These meetings are NOT for the formation of another organization, but are intended for the mutual exchange of useful information.

In all but the official announcement, Broadmoor Industries has gone out of business, according to *Home Furnishings Daily*. Broadmoor hasn't shipped any goods since February, and the company holding the merchandise lien has sold the Broadmoor inventory to Olympic International, along with the Broadmoor name.

(Continued on page 6)

TUNER SERVICE CORPORATION

SUBSTITUNER



JUST

\$44.95
U.S.A. ONLY

WITH CABLES

ONE YEAR
GUARANTEE

STILL ONLY

\$9.95
U.S.A. ONLY



MAJOR PARTS
AND SHIPPING
CHARGED AT COST

FEATURES

- A UHF Tuner with 70 channels which are detented and indicated just like VHF channels.
- A VHF Hi Gain Solid State Tuner.
- AC Powered • 90 Day Warranty

Demonstrate the **SUBSTITUNER** to your customers and show improved reception with their TV sets.

You may place your order through any of the Centers listed below.

NEWS FLASH!

NOW AVAILABLE—TUNER SERVICE PARTS CATALOG OF ALL SARKES TARZIAN VHF AND UHF TUNERS, INCLUDING EXPLODED VIEW DRAWINGS. OVER 200 PAGES. ORDER YOUR COPY TODAY. SEND \$2.50 WITH ORDER TO BLOOMINGTON HEAD OFFICE.

PROVIDES YOU WITH A COMPLETE SERVICE FOR ALL YOUR TELEVISION TUNER REQUIREMENTS.

REPAIR

VHF OR UHF ANY TYPE (U.S.A. ONLY) \$ 9.95
UHF/VHF COMBINATION(U.S.A. ONLY) \$15.00

MAJOR PARTS AND SHIPPING
CHARGED AT COST

- Fast, efficient service at our conveniently located Service Centers.
- All tuners are ultrasonically cleaned, repaired, realigned, and air tested.

REPLACE

UNIVERSAL REPLACEMENT TUNER \$12.95 (U.S.A. only)

- This price buys you a complete new tuner built specifically by Sarkes Tarzian Inc. for this purpose.
- All shafts have a maximum length of 10½" which can be cut to 1½".
- Specify heater type parallel and series 450 mA. or 600 mA.

CUSTOMIZE

- Customized tuners are available at a cost of only \$15.95. With trade-in \$13.95. (U.S.A. only)
- Send in your original tuner for comparison purposes to any of the Centers listed below.

TSC

HEADQUARTERS	BLOOMINGTON, INDIANA 47401	537 South Walnut Street	Tel. 812-334-0411
ARIZONA	TUCSON, ARIZONA 85713	1528 S. 6th Ave.	Tel. 602-791-9243
CALIFORNIA	NORTH HOLLYWOOD, CALIF. 91601	10654 Magnolia Boulevard	Tel. 213-769-2720
	BURLINGAME, CALIF. 94010	1324 Marsten Road	Tel. 415-347-5728
	MODESTO, CALIF. 95351	123 Phoenix Avenue	Tel. 209-521-8851
CONNECTICUT	BRIDGEPORT, CONN. 06606	813 Madison Ave.	Tel. 203-385-0620
FLORIDA	TAMPA, FLORIDA 33606	1505 Cypress Street	Tel. 813-253-0324
	FT. LAUDERDALE, FLORIDA 33315	104 S.W. 23rd St. Bay to	Tel. 305-524-0914
	MIAMI, FLORIDA 33150	7641 N.W. 7th Ave.	Tel. 305-754-1352
GEORGIA	ATLANTA, GA. 30310	646 Evans St. S.W.	Tel. 404-768-2332
ILLINOIS	CHAMPAIGN, ILLINOIS 61820	405 East University Street	Tel. 217-956-6400
	DALTON, ILL. 60419	1507-09 E. 142nd St.	Tel. 312-641-4444
	SKOKIE, ILLINOIS 60076	5110 West Brown Street	Tel. 312-875-0230
INDIANA	INDIANAPOLIS, INDIANA 46204	112 West St. Clair Street	Tel. 317-632-3493
IOWA	DES MOINES, IOWA 50319	5005 Douglas St. #5E	Tel. 515-278-4217
KENTUCKY	LOUISVILLE, KENTUCKY 40205	2244 Taylorsville Road	Tel. 502-452-1191
LOUISIANA	SHREVEPORT, LOUISIANA 71104	3025 Highland Avenue	Tel. 318-221-3027
MARYLAND	BALTIMORE, MARYLAND 21215	5505 Reisterstown Rd., Box 268	Tel. 301-358-1186
MASSACHUSETTS	SPRINGFIELD, MASS. 01108	405 Dickinson St.	Tel. 413-788-8206
MISSOURI	ST. LOUIS, MISSOURI 63132	9577 Page Avenue	Tel. 314-429-0633
NEVADA	LAS VEGAS, NEVADA 89102	1412 Western Avenue No. 1	Tel. 702-384-4235
NEW JERSEY	TRENTON, NEW JERSEY 08638	1139 Pennsylvania Ave.	Tel. 609-393-0999
	JERSEY CITY, NEW JERSEY 07307	547-49 Tonnet Ave., Hwy. 1 & 9	Tel. 201-792-3730
NEW YORK	ROCHESTER, NEW YORK 14615	37 Pullman Ave.	Tel. 716-647-9180
N. CAROLINA	GREENSBORO, N.C. 27405	2914 E. Market Street	Tel. 919-273-6276
OHIO	CINCINNATI, OHIO 45216	7450 Vine Street	Tel. 513-821-5080
	CLEVELAND, OHIO 44109	4525 Pearl Road	Tel. 216-741-2314
OREGON	PORTLAND, OREGON 97210	1732 N.W. 25th Ave., P.O. Box 10141	Tel. 503-222-9059
PENNSYLVANIA	PITTSBURGH, PA. 15209	515 Grant Avenue	Tel. 412-821-4004
TENNESSEE	MEMPHIS, TENNESSEE 38111	3158 Barron Avenue	Tel. 901-458-2355
TEXAS	DALLAS, TEXAS 75218	11540 Garland Road	Tel. 214-327-8413
VIRGINIA	NORFOLK, VIRGINIA 23513	3295 Santos Street	Tel. 804-855-2518
CANADA	ST. LAURENT, QUEBEC H4N-2L7	305 Decarie Boulevard	Tel. 514-748-8803
	CALGARY, ALBERTA T2H-0L1	448 42nd Avenue S.E.	Tel. 403-243-0971
		P.O. Box 5823, Stn. "A"	

WATCH US
GROW

IF YOU WANT TO BRANCH OUT INTO THE TV TUNER REPAIR BUSINESS, WRITE TO THE BLOOMINGTON HEADQUARTERS ABOUT A FRANCHISE.

For More Details Circle (6) on Reply Card

www.americanradiohistory.com

(Continued from page 4)

Touch-sensitive capacitance-type switches are becoming popular in microwave ovens, although the light, stop, and start buttons still must be pushbuttons at present. **Electronic News** says the touch-sensitive switches make possible a smooth glass panel. Some companies are researching digital switches without any moving parts.

VIZ Manufacturing has formed a new group to market its line of test equipment. VIZ acquired RCA's line (which VIZ had been producing) and will continue those instruments, while adding new devices to the line.

California has banned gas pilot lights on major appliances starting in 1978. According to state officials, the ban is intended to save 22 billion cubic feet of natural gas per year.

Workman Electronics has purchased equipment, inventory, and part numbers of the dealer service and hobbyist packaged lines of transistors, zener diodes, and other components from International Rectifier. Only IR's Commercial Products Distributors (CPD) division was affected.

The recent NARDA convention in Las Vegas brought many suggestions for survival in modern appliance businesses, reports **Home Furnishings Daily** in several articles. Irv Weiss, the keynote speaker, strongly suggested private-label merchandise for NARDA members to combat discount competition. NARDA service manager, John Gooley, recommended adding 25% to the sales costs of parts to cover freight, shrinkage, and other expenses. The shortage of technicians has been eased by the fewer repairs on solid-state sets; however, the standards must be higher because the circuits are more complex.

Tom Peterson recommended these ideas: a monthly inventory; always be in first place (selling 200 CB radios per month now); don't copy competition; forget the job two days a week; and have a profit plan with weekly budgets. Roy Jansen suggested these things his company did to improve profit: rented service trucks, freeing capital; increased advertising; changed from FIFO to LIFO accounting, began selling microwave ovens; and joined a buying group. Many dealers said they would continue selling TV's, but with a second line to fight price competition. The repair and sale of used appliances was recommended by many managers. NARDA is the National Appliance & Radio-TV Dealers Association located at 318 West Randolph Street, Chicago, Illinois 60606.

The Sound Gallery of Cambridge, Massachusetts is trying to change the stereo-shopping "nightmare" into an experience of "sheer delight". Stanley Hollander, Vice President of Brands Mart, decided an entirely new approach to merchandising and consumer education was needed. After extensive research, he assembled "The Sound Gallery" at the Brands Mart outlet. This futuristic sound environment is set in a large modernistic space with curving walls, and a near-perfect acoustical balance. The space contains two mini-theatres, and all of the mechanics are controlled by a computer. Presentations called "The Shiny Vinyl Canned Grand Canyon Tour" and "Speakers and Spaces", guide the viewer/listener through the intricacies of the audio world in an entertaining and enlightening manner. "The Shiny Vinyl Canned Grand Canyon", for example, is actually the groove of a phonograph record, magnified thousands of times. The listener begins the experience deep within the "canyon" and is taken, step by step, through the vinyl record groove walls until he understands exactly what sound is. The second presentation, "Speakers and Spaces", deals with every aspect of speakers.

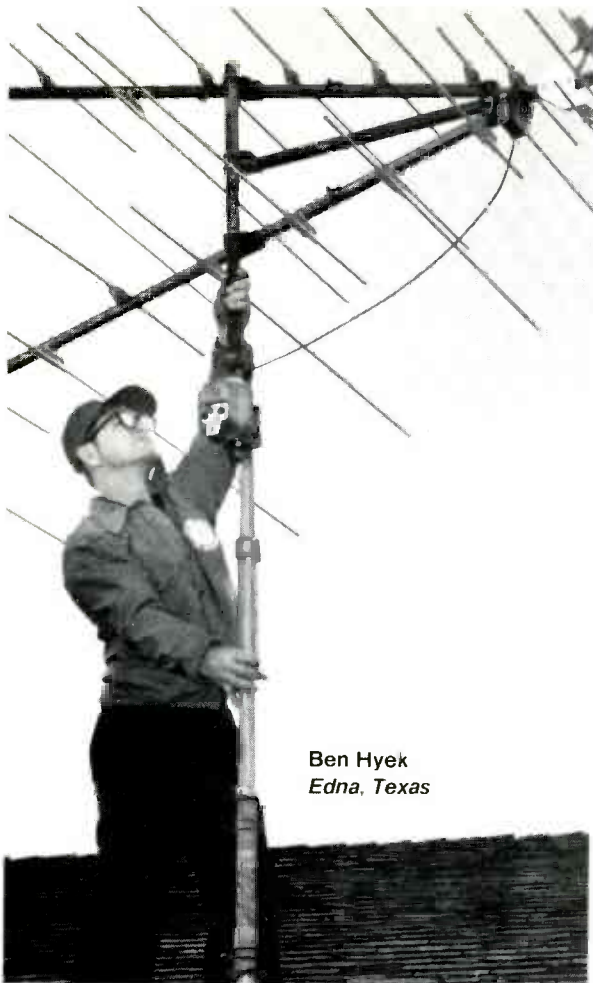

Ben Hyek
Edna, Texas

Brothers Ben and Vic Hyek,
Texas antenna installers agree:

Chromstar gets the "Ayes" of Texas

Deep in the heart of Texas, the Hyek brothers, Ben and Vic, operate their separate TV service firms.*

Ben Hyek, of Ben's TV, Edna, Texas, says "I have yet to find a competitor's antenna as good as Winegard Chromstar."

Only 30 miles from the Gulf, Ben sells the anodizing feature to his customers. "The combination of heavy duty construction and anodizing makes Chromstar the best long-life antenna on the market," he states. When he sells Chromstar, he tells the customer, "If it doesn't work, I'll take it down," and he hasn't taken one down yet.

Vic Hyek operates Vic's Radio & TV, Nada, Texas, and says: "I think Chromstar is by far the greatest antenna Winegard has ever offered. UHF performance is excellent, and VHF is better, too. Now I can pick up Channel 39 out of Houston, over 60 miles away, better than I have before. UHF performance in this area doesn't require a preamp."

Both Vic and Ben like the stronger construction of Chromstar, the ease of installation, the new color combination, and the compact packaging that allows easy handling and storage.

*Copies of letters from the Hyek brothers will be sent on request.

Get Chromstar facts and free Spec Charts from your Winegard distributor.



Vic Hyek, Nada, Texas

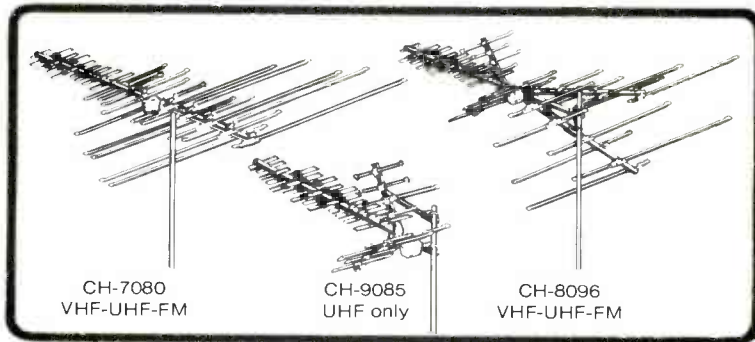

WINEGARD
COMPANY
3000 Kirkwood • Burlington, Iowa 52601

TV ANTENNAS MORE PEOPLE LOOK UP TO

Chassis—Philco-Ford 4CY80
PHOTOFACT—1430-2

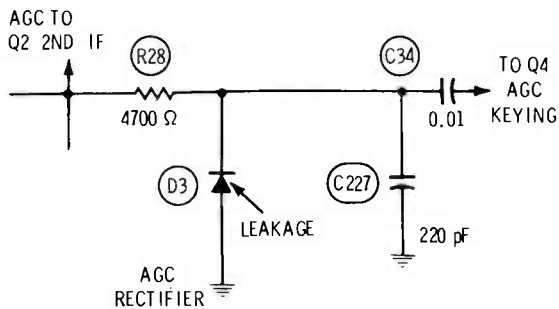

Symptom—Excessive contrast or overload; little snow with no signal
Cure—Check diode D3, and replace it, if leaky

Chassis—Philco-Ford 4CY80 (all hybrid)
PHOTOFACT—1430-2

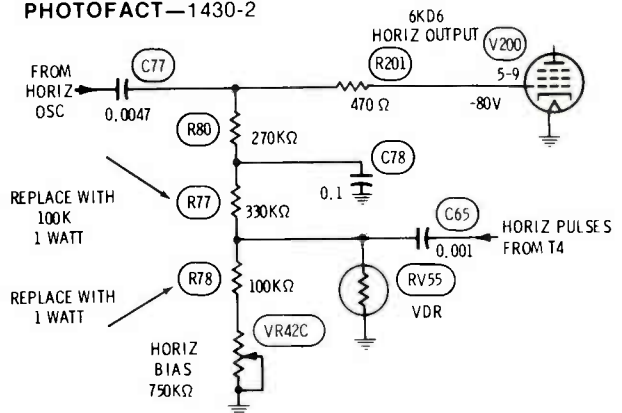

Symptom—Three black vertical lines
Cure—Replace R77 and R78 with 1-watt units, and change R77 to 100K

Chassis—Philco-Ford 20ST30B (b&w)
PHOTOFACT—1172-3

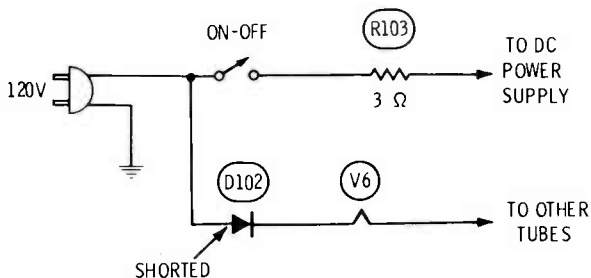

Symptom—Excessive tube failures
Cure—Check diode D102, and replace it, if shorted

Chassis—Philco-Ford 5CM31A
PHOTOFACT—1462-2

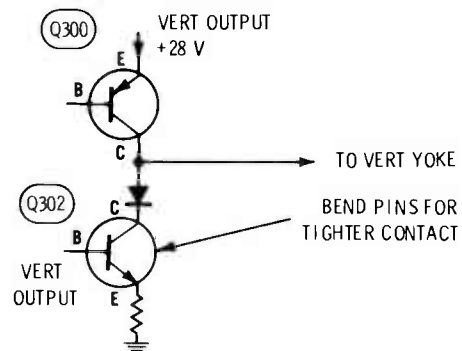

Symptom—White horizontal line at top
Cure—Bend pins of Q302 for tighter contact in the socket

Chassis—Philco-Ford 5CS51-61-62-63
PHOTOFACT—1487-3

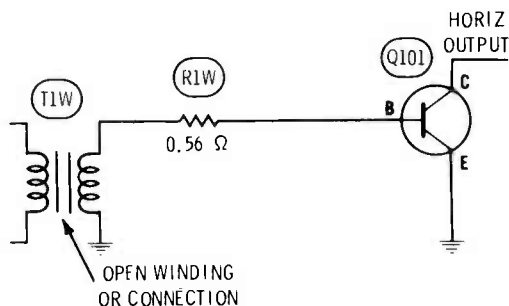

Symptom—No sound or raster
Cure—Check for open windings or connections of T1W

Chassis—Philco-Ford 5CS51-61
PHOTOFACT—1487-3

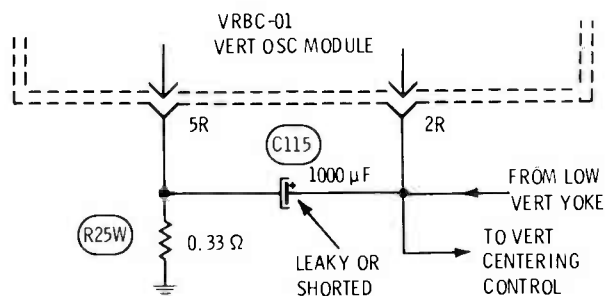

Symptom—No height, or insufficient height
Cure—Check C115, and replace it, if shorted or leaky

AGC overload on strong signals Broadmoor Model 2019

(Photofact 1429)
(K-Mart Model SKP1920)

In these color receivers, the fly-back pulse for the AGC circuit sometimes arcs over to the unused pin 2 of the 21GY5 socket. The circuit wiring is hard to see at this point.

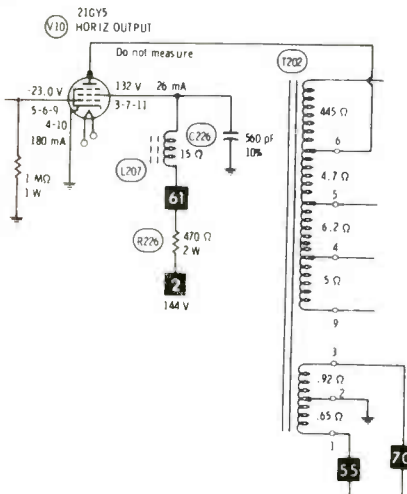

Thoroughly scrape away all the burned path, or cut out that piece of the wiring and substitute a piece of insulated wire, to prevent any recurrence.

Cecil Mick
Schwarzwald TV
Paducah, Kentucky

Linearity stretched at top General Electric Chassis C-2

(Photofact 1231-2)
First, I tried to adjust the vertical height and linearity. The height control worked normally, but the linearity control had no effect. I checked resistances of the control and the resistors around it, but all were okay.

Also, the high voltage was all right, but when I turned down the brightness, I noticed the HV regulation wasn't working. Testing of the components of the HV regulation circuit revealed that diodes Y252 and Y253 were open.

After I replaced the regulation diodes, the HV regulation was normal, but I was surprised to find

that the vertical-linearity control also now worked normally. A look at the Photofact showed the reason.

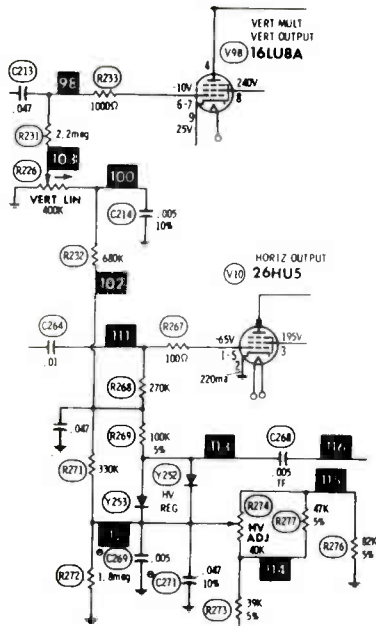

Negative voltage for the linearity control comes from the HV regulator circuit (see combined schematics) through R232. This is another example of symptoms (apparently not related) coming from a common defect.

Earl Breeding, CET
Green Cove Springs, Florida

Poor skin tones General Electric 19QB

(Photofact 1471-1)
In this model, the demodulator IC (IC501) is the first suspect for wrong hues. All the DC voltages at IC501 were within tolerance. I changed the IC, but the hues remained all wrong.

Color saturation was good, indi-

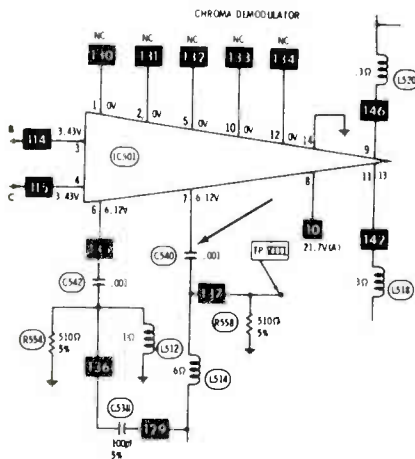

(Continued on page 11)

FAST

COMPLETE SERVICE ON ALL MAKES OF TV TUNERS

Maximum Time In Shop 24 Hrs.

(Warranty: One Full Year)
(WE SHIP C.O.D.)
YOU PAY SHIPPING
\$9.95

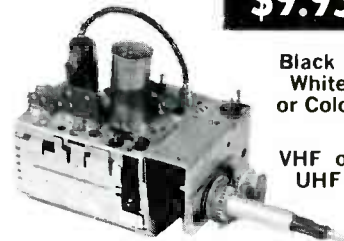

Black & White or Color
VHF or UHF

UV Combo's \$16.50

Price includes all labor and parts except Tubes, Diodes & Transistors. If combo tuner needs only one unit repaired, disassemble and ship only defective unit. Otherwise there will be a charge for a combo tuner. When sending tuners for repair, remove mounting brackets, knobs, indicator dials, remote fine tuning arrangements and remote control drive units.

WE UNCONDITIONALLY GUARANTEE All Tuners FOR ONE FULL YEAR



All tuners are serviced by EXPERTLY TRAINED TECHNICIANS with years of experience in this specialized field. All tuners are ALIGNED TO MANUFACTURER'S SPECIFICATION on crystal controlled equipment and air checked on monitor before shipping to assure that tuner is operating properly.

GEM CITY TUNER SERVICE

Box 6G Dabel Station
1621 Mardon Drive
Dayton, Ohio 45420

reader's exchange

Needed: Schematic for Precision Model 98 vacuum-tube voltmeter. Will buy, or copy and return.

Thomas C. Alexander
4811 Church Street
Greensboro, North Carolina 27405

Needed: Complete service information about Allied FM communications receiver Model A-2589. Will buy, or copy and return.

David Trinkle
Route 3
Bluff City, Tennessee 37618

Needed: Schematic and tube layout for Saba Model 300 AM/FM shortwave radio; also power transformer #3819, 101 and 111.

Glenn Farrar
100 Gary Street
South Paris, Maine 04281

Wanted: Stereo-system analyzer, Amphenol Commander Model #880.

The University of Rochester
School of Medicine and Dentistry
601 Elmwood Avenue
Rochester, New York 14642
Attn: Ralph C. Sahn, CET

For Sale: Rider's radio manuals 6 to 14; antique radio and TV tubes such as 00A, 01A, 40, 99, VT67, 7F7, 7B8, 25B8, FM-1000, etc.

Goodwin Radio Shop
Rankin, Illinois 60960

Needed: Schematic for Zenith Model 808 superhet.

Mario Mere
Audionics Ltd.
119 Webbers Path
W. Yarmouth, Massachusetts 02673

For Sale: Jackson sweep/marker generator, Model TVG-2, without leads but in good shape, \$10. Also, Eico Model #460 scope with 3 probes (guaranteed good), \$25, and B&K multimeter Model #277, (guaranteed good), \$25.

Daley's TV
Preston, Minnesota 55965

For Sale or Trade: B&K CRT rejuvenator/checker, new condition, \$110.

R. J. Horsley
67 Theodore St.
Buffalo, New York 14211

(Continued on page 56)

QT Parts are never out of date.



It's a fact. The RCA QT (Quick Turnover) Parts Program is more than ten years old, but it's still brand new as far as keeping your parts inventory always up to date. The reason — our computer is constantly up-dating the three QT parts packages available. No matter which one you order, or when you order it, you always get the most needed parts. This saves you time and money with no inventory risk.

Choose from three QT parts packages.

The smallest, DP50 contains 50 parts; DP100 contains 100 parts; and the largest, DP175 contains 175 parts. And, to make inventory control easy, ask your RCA Distributor about the QT Parts Rack. A complete inventory control system for storing parts.

Call your RCA "QT" Parts Distributor for all the details, or write to RCA Distributor and Special Products Division, Sales Promotion Services, Cherry Hill, NJ 08101.

RCA QT Parts

cating demodulator trouble. Of course, a 3.58-MHz carrier of the correct phase is necessary at each demodulator, and a test of that required a scope.

At pin 6, a carrier of about the right amplitude was found. But, at pin 7, the carrier amplitude was only about .1-volt PP. I switched to an ohmmeter, and soon found that L514 and R558 were okay. The only component remaining was C540. When I replaced C540, the hue control could adjust in normal skin tones.

These facts emphasize the importance of scope waveforms where DC voltages are normal.

L. Luchi
Television Service Center
Pasco, Washington

Weak contrast Magnavox Chassis T962 (Photofact 1253-2)

The picture was stable and had color, but the contrast was very weak. In the home, I tried the 100 microfarad capacitor (that's mounted on the contrast control), but it didn't help. When video tube replacements didn't improve the contrast, I brought the chassis to the shop.

DC voltages at pins 1 and 3 of the 6MU8 V204 video tube were low, about 50 volts less than usual. Also, the 128-volt source measured low voltage, although the +140 supply was okay.

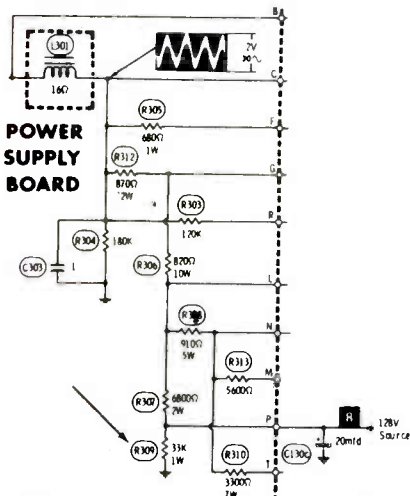

The suspects were R307, R309, and C130C, and a few quick ohmmeter tests showed that R309 was only about 2500 ohms, instead of 33K. Yes, replacement of R309 restored full contrast.

Charlie Jackson
Buckner, Illinois

Put safety first ... Use RCA flameproof film resistors .

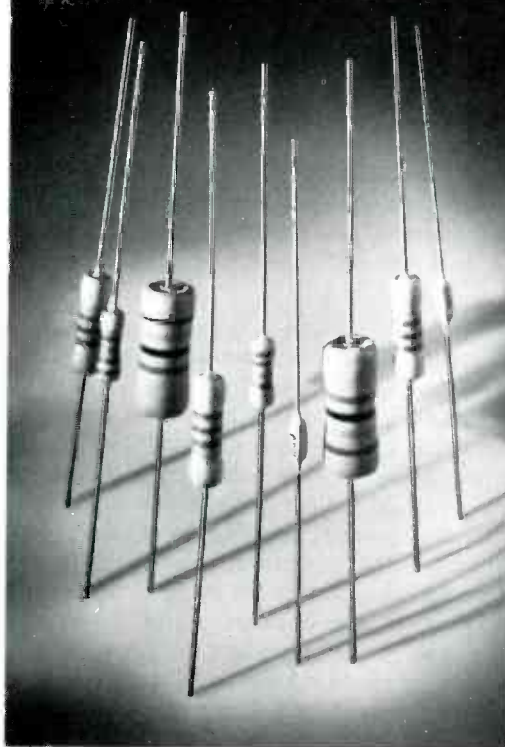

Design engineers prefer them because they won't flame or short under the most severe conditions. Service technicians prefer them because they're safe replacement parts.

RCA flameproof film resistors have a 2% tolerance and are available in 1/4 watt, 1/2 watt, 1 watt, and 2 watt ratings. Resistance values range from 10 Ohms to 1.5 Megohms, depending on wattage rating. Altogether, there are 475 film resistors to choose from.

See your RCA Distributor for all the details, or write to RCA Distributor and Special Products Division, Sales Promotion Services, Cherry Hill, NJ 08101.

RCA

Flameproof Film Resistors

The "New Generation" Flat-Rate Pricing...

is proving itself in thousands of shops from coast to coast—it prices your work profitably while creating customer good-will.

Fast tab indexing to 19 major repair categories prices all bench, home and over-the-counter repairs with authority.

tv & radio tech's guide to pricing

Plus, Computerized Pocket-Size Parts Catalog.

Customized to your desired parts profit. Lists over 3500 most-used parts, continually updated. Can easily recover initial investment in less than 30 days... \$75.00 plus \$10.00 per catalog.

P.O. Box 5234
Lincoln, NE 68505

sperry tech inc.

___ copies, Hardbound. ___ copies, Satellite
___ copies, Parts Catalog. More information
___ Amount enclosed, check or money order.
(NE res. add sales tax)

NAME _____
CO. _____
ADDRESS _____
CITY _____
STATE _____ ZIP _____

Professional
6 × 9 hard cover,
steel ring-bound
edition...
\$18.95 ea. post pd.

Satellite Edition...
the same system described
above, only reduced to
shirt-pocket size for
outside service...
\$16.95 ea. post pd.
Quantity prices available.

Reports from the test lab

By Carl Babcoke

Each report about an item of electronic test equipment is based on examination and operation of the device in the ELECTRONIC SERVICING laboratory. Personal observations about the performance, and details of new and useful features are spotlighted, along with tips about using the equipment for best results.

Tuning Musical Instruments

Tuning most musical instruments can be done quickly and accurately, if you know how, and have a Conn Strobotuner. For example, the first organ tuning I did with it required about five minutes. But then I had to wait for another ten minutes until the organ (not the Strobotuner) stopped drifting, and I could do a 4-minute final touchup. There were only 12 adjustments for an organ with 147 separate notes.

Contrast that easy job to a piano "tuner" who adjusts middle "A" against a tuning fork, and laboriously tunes the "fifth" above by striking both keys while listening for the beats between the harmonics of the two notes as he adjusts the pin of the higher note. By working with the proper pairs of notes in a certain sequence, he finally sets the "temperament" of the middle octave of 12 notes. Then he must work from those notes up to the top and down to the bottom of the keyboard, tuning the octaves carefully by "stretched" tuning. Because there are 88 notes and about 180 separate strings to be tuned, it's easy to see why such a procedure takes between an hour and two hours!

In fairness, I must say a piano tuner could save some time and much concentration, if he also used a Strobotuner. I don't recommend that you attempt to tune pianos, but I promise that with a Strobotuner you could tune a guitar or an electronic organ just as fast and as perfectly in-tune as the best piano tuner could.

Model ST-11 Strobotuner

The Conn Strobotuner operates on the stroboscopic principle, the same one that sometimes shows the

wheels of a covered wagon in the movies **apparently** moving in reverse. Also, stroboscopic cardboard patterns can be placed on top of a phonograph record. When the lines seem to be standing still, the speed of the turntable is correct. The light source, supplied by 60-Hz power, is the standard, and the turntable rotation is the thing to be measured.

By contrast, the Strobotuner spins a pattern of lines at a very steady and accurate speed (the standard), while the musical note (the thing being measured) flashes a neon bulb once for each cycle of the audio tone. When the note has the correct frequency, the lines appear to be motionless.

Basics Of Musical Pitch

A few fundamentals of music should be understood before you start to tune any kind of musical instrument. Most of the essentials are illustrated in Figure 1.

There are only seven primary notes of any musical scale; they are named after letters of the alphabet—A through G—in order of ascending pitch (frequency). Then above G, the letters start over at A again and go to G. And so on, for as many octaves as are on the instrument, or written by notation on the music. An octave is a note exactly twice or half the frequency of the first.

The octave range of notes in Figure 1 starts at C and goes up to B, the seventh and final note of that scale. The eighth note is C, an octave above (twice the frequency) of the first C. Notice the short, black keys between some white keys. They are necessary to complete the "chromatic" scale, furnishing accidentals, and allowing music

to be played in many key signatures. Each of the twelve notes is called a "semi-tone".

The white keys (called "naturals") are evenly spaced on a keyboard, but the black ones (called "sharps" and "flats") are in two groups, two together and three together. This makes identification of the keys easy (although that was not the primary reason it was done). A C note always is just to the left of the left one of the two black keys. Other notes can be located by their position relative to other black keys.

Other octave scales of notes are arranged exactly like the one shown. Therefore, twelve separate frequencies are the minimum necessary to determine the tuning of a musical instrument (other notes are merely octaves of these twelve).

Equally-Tempered Scale

Many centuries ago instruments were tuned to the "natural" scale, allowing "chords" (harmonious groups of notes) to sound in perfect pitch. However, if the instrument was required to play in a different key, a retuning was necessary, otherwise some chords were sour.

Eventually, a compromise tuning of the twelve semi-tones was adopted. With this scale (called "equally-tempered", or "tempered" for short), each semi-tone is the same percentage from the one above it, and music can be played in any key signature without retuning. Yes, this gives some small errors, but they are so small most musicians are not aware of them. It makes the third note of a chord slightly sharp (higher in frequency) and the fifth note slightly flat (lower in frequency).

A natural field for TV technicians is the repair and tuning of electronic musical instruments, such as organs. This article explains the basics of tuning these instruments, and a description and operation of the Conn Strobotuner, which can be used to tune any musical instrument. In the June issue, Norman H. Crowhurst, one of the real experts in the audio field, starts a series covering the theory and repairing of electronic organs. Watch for it!



Testing or resetting the tuning of an electronic organ is easy and fast, with the Strobotuner.

Now, you might imagine that, because there are 12 semi-tones, each one would differ from its neighbor by 1/12th of the lowest note. That's wrong! Instead, each higher semi-tone increases in frequency by a ratio of 1 to the twelfth root of 2 (1.059463). In other words, to go from A-440 to A#, just multiply 440 Hz by 1.059463, giving 466.16 Hz. Other notes can be calculated by the same method.

We'll not dwell on these figures, because they are not used during the actual tuning of musical instruments. However, they do give an indication of the precision that's necessary for perfect tuning.

Cents

In practical tuning of musical instruments, seldom are frequencies used directly. Probably that's because of the mathematical difficulties. Each note has a different frequency, and to discuss an error in terms of the frequency in Hertz would require a calculator.

Instead, the word "cents" is used to describe small variations of frequency. Each semi-tone has 100 cents, thus making 1200 cents the total for the 12 semi-tones of each octave.

One cent of an A-440 note is 1/100th of the difference between A-440 and A#-466.16. By calculation, that one cent is 0.2616 Hertz (or 0.059% of the A-440 frequency).

Good musicians probably can detect (and disapprove of) tuning errors of only about 5 cents (0.3% error). This gives you an idea how difficult tuning instruments would be, if done electronically by frequency alone.

Strobotuner

The Conn Model ST-11 Strobotuner seems deceptively simple for an instrument rated at an accuracy of 1 cent (0.05%). On the front panel are a dial window, a mike jack, and four controls (Figure 2).

However, the nine IC's used inside are an indication of the modern circuits.

Basic operation

A synchronous motor (which rotates in step with the frequency of the power applied) must be supplied with 12 different frequencies for the semi-tones, plus one for calibration, to spin the strobe pattern (Figure 3).

These precision frequencies are obtained by dividers from one high-frequency oscillator (same principle as some new organs), so all change together during drift (negligible) or calibration. A SELECTOR knob (see Figure 4) determines the frequency of the motor power.

Input to the Strobotuner can be acoustic through the microphone that's supplied, when it is plugged into the MIC jack. This is for instruments, such as trumpets or pianos, which do not usually have an electronic signal.

To bring in signals from amplifiers, make up a shielded cable with a phone plug for the tuner on one end, and clips on the other. Plug this cable into the MIC jack. Use moderate care not to overload the input with excessive level. A setting between 3 and 6 on the GAIN control (Figure 5) is desirable, when the dial has full brilliance.

In either event, the level should be gradually increased until the orange glow behind the strobe pattern barely reaches full brilliance. Background noises might interfere, if the gain is excessive.

Audio from the MIC jack is amplified and applied to several neon bulbs that illuminate the rear of the spinning strobe pattern. When the blocks or lines appear to be standing motionless, the strobe pattern and the neon flashes are in synchronism (at same octave).

If the lines appear to be moving clockwise, the frequency of the external signal is too fast (sharp). Of course, the lines appearing to move in a counterclockwise direction indicate the signal is too low of frequency (flat).

Identifying the octave

Bands of lines for the different octaves are marked by semi-circular patterns. To find the octave of the note, look for the lowest-numbered band which has motionless lines. There also is a special circuit which twice divides the frequency of the incoming signal. This raises the highest frequency that can be measured by two octaves. These octave bands are marked on the right side of the strobe dial, and they are selected by the +2 setting of the FUNCTION switch.

Calibration and the CENTS knob

The FUNCTION switch (Figure 6) has four positions. AC power is disconnected at OFF. At the CAL position, the AC is turned on, and

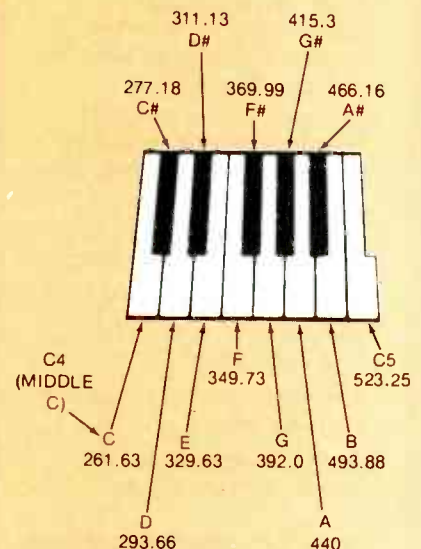

Fig. 1 These are the notes and their frequencies of one keyboard octave. Each frequency is multiplied by 1.059463 to produce the next higher note.

TEST SEMICONDUCTORS ANYWHERE

Portable,
in-circuit tester
for all bipolar
transistors,
Darlingtons,
FETs,
SCRs



B&K-PRECISION
MODEL 510 \$90

- Combines Dynapeak™ testing method with HI/LO power drive
- Tests semiconductors and identifies all leads; base, emitter, collector in LO drive
- Provides GOOD/BAD indicator in circuits with shunt resistance as low as 10Ω; shunt capacitance up to 25 μF, in HI drive
- Test performed as quickly as one can turn the switch
- Measures 6 5/8" x 3 3/4" x 1 3/4"
- Weighs 1/2 pound, less four "AA" batteries
- Price includes test clips and carrying case
- Available from local B&K-PRECISION distributors

B+K PRECISION
PRODUCTS OF DYNASCAN

1801 West Belle Plaine Avenue
Chicago, Illinois 60613 312/525-3990
In Canada: Atlas Electronics, Toronto

the circuits are switched for calibrate, which requires the CENTS control, located just above the FUNCTION switch (Figure 7).

During calibration, the neon lamps operate from 60-Hz power, so the motor speed is adjusted to the standard power frequency. Because huge areas of the country are tied into one power grid, the power companies maintain a very-accurate 60-Hz frequency.

For normal tuning of instruments, the pointer of the CENTS knob is not needed, and can be left where it is. For calibration, the CENTS knob is just rotated as needed to stop movement of the strobe lines, then the FUNCTION switch is turned to NORM (normal) and the instrument being tuned is adjusted until the lines again stand motionless for the notes selected by the SELECTOR.

Testing frequency, not note

But for situations where the frequency must be known, but not tuned, the pointer should be turned to zero, after the strobe lines stop during calibration. Then the FUNCTION switch is changed to NORM, the SELECTOR turned for approximate frequency, and the CENTS knob used as a fine-tuning control to stop the strobe lines. The reading is the letter of the note from the SELECTOR plus the



Fig. 2 The Model ST-11 Strobotuner is ready to be connected to the organ that needs tuning.

number of cents flat or sharp. From this, the exact frequency can be looked up in a cents-to-frequency book.

These tests are useful where the frequency is not related to music, or when the frequency is not under your control. You can even test the precise vertical or horizontal sweep frequency this way!

Now, how did the device prove in actual operation?

Tuning Electronic Instruments

Because I have been an amateur musician most of my life, I am not reluctant to tune instruments. In addition to guitars, violins, and other stringed instruments, I have tuned and repaired Novachords, Solovox keyboards, pianos, and many more.

However, I had never tuned our big 30-year-old Baldwin organ. It sounded in-tune with itself and with a mechanical harp unit I had added. This organ is one of the kinds with 12 master oscillators, followed by dividers to produce all notes of lower pitch. Therefore, only 12 adjustments were required. It seemed an ideal one for practice.

Using the Strobotuner as the standard, I found a couple of notes that were a few cents wrong, but no serious errors.

But this first tuning job showed me one of the values of the Strobotuner: **it gives you confidence, so you are not afraid to turn the tuning adjustments!**

Organ and piano

For some time, both the piano and organ at the church had played a little sour, and especially together.

Checking the piano with the Strobotuner, I found most of the notes about 5 cents **sharp**. That's unusual, because most stringed instruments tend to go flat between tunings. Probably the last tuner had left it sharp, hoping to cancel the expected drift. I didn't tune the piano, using the excuse that I could not find my tuning "hammer".

The spinet Lowrey organ was out of tune with itself, and tended to be flat on all notes. Piano tuning which is sharp and organ notes that are flat can make quite a discord!

One of my TV alignment tools fit the tuning slugs of the Lowrey, and only a few minutes time were required to bring the tuning up to



Fig. 3 There are eight semi-circular bands of lines visible through the window. Each band is a different octave. The normal octaves are marked on the left, the +2 octaves (octaves 2 through 10) are labeled on the right. With correct tuning, the lines of one or more bands appear to be motionless. When the note is flat, the lines move to the left (counterclockwise), or sharp notes move the lines to the right (clockwise).

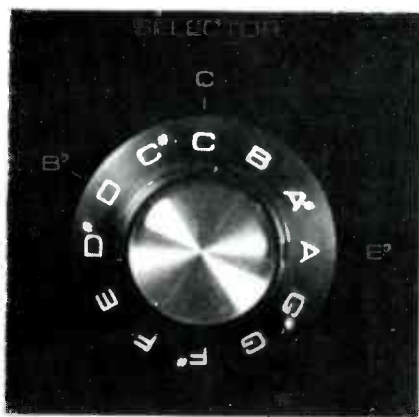

Fig. 4 Twelve semi-tones are marked on the SELECTOR knob. Marked on the panel in silver are the notes for instruments using transposed tuning. Most instruments, including organs and strings, are tuned with the desired note at the top under "C".

concert pitch. The only problem was in finding the right slug.

I didn't have any service information for the organ, but the layout plainly showed 12 strips with a tuning coil at the end of each. Organs with full 61-note keyboards usually start with a C as top note. However, this one had an F at the top. Which adjustment was for which note?

If the oscillator coil is not shielded, you can hold down one note on the keyboard as you move a metal screwdriver blade up against

one coil after another. The pitch of the note usually will go flat when you reach the right one.

After I located which coil tuned the top note, the tuning job proceeded without any problems.

Even though the piano was not tuned, the two instruments now are near enough in tune that I don't flinch at the first chord. The next piano tuning should correct the small remaining discord.

Hints About Strobotuner

Although the Strobotuner instruction book mentions the strobe pattern standing motionless, they also say correctly that the sensitivity of the method allows a small movement. This individual machine had a tiny bump in the motion of the pattern; not much, but it could be seen. Ignore this, if your machine does it.

Conn recommends a 60-second warm-up time. The unit is solid-state, and the stability is excellent. In most cases, you will find the instrument you're tuning will drift far more than does the Strobotuner. And, if it is correctly calibrated, the Strobotuner accuracy is about 5 times better than what is needed for most musical requirements.

So, don't be concerned with a small rotation of the strobe pattern. If it appears to make a full circle revolution in several minutes, that's good enough.

Vibrato effects

Musically speaking, vibrato makes a note warble by a change of frequency at about 6 Hz. Some organs change frequency slightly when the vibrato is turned on. If the strobe pattern is virtually motionless with the vibrato off, a perfect machine should make the pattern seem to rock slightly right and left alternately.

Ignore any small changes of frequency from the vibrato (say, a couple of cents). However, larger errors require a decision, and usually a compromise. If the organ always is played with vibrato, then tune it with the vibrato on. Otherwise, split the difference. Adjust the tuning about halfway between the two conditions.

Pattern hesitations

Because the motor that drives the strobe pattern is supplied with a

ARROW AUTOMATIC STAPLE GUNS

CUT WIRE & CABLE INSTALLATION COSTS

... without cutting into insulation!

SAFE! Grooved Guide positions wire for proper staple envelopment! Grooved Driving Blade stops staple at right depth of penetration to prevent cutting into wire or cable insulation!

No. T-18—Fits wires up to 3/16" in diameter.

BELL, TELEPHONE, THERMOSTAT, INTERCOM, BURGLAR ALARM and other low voltage wiring.

Uses T-18 staples with 3/16" round crown in 3/8" and 7/16" leg lengths.

No. T-25—Fits wires up to 1/4" in diameter.

Same basic construction and fastens same wires as No. T-18.

Also used for RADIANT HEAT WIRE

Uses T-25 staples with 1/4" round crown in 9/32", 3/8", 7/16" and 9/16" leg lengths.

NEW! Intermediate No. T-37—Fits wires and cables up to 5/16" in diameter.

Same basic construction as Nos. T-18 & T-25.

Also used for CATV and DRIVE RINGS in stringing wires.

Uses T-37 staples with 5/16" round crown in 3/8", 1/2" and 9/16" leg lengths.

No. T-75—Fits wires and cables up to 1/2" in diameter.

RADIANT HEAT CABLE, UF CABLE, WIRE CONDUIT COPPER TUBING or any non-metallic sheathed cable.

Also used as DRIVE RINGS in stringing wires.

Uses T-75 staples with 1/2" flat crown in 9/16", 5/8" and 7/8" leg lengths.

ARROW FASTENER COMPANY, INC.

271 Mayhill Street, Saddle Brook, N. J. 07663

For More Details Circle (11) on Reply Card



Fig. 5 At the lower left corner of the panel are the microphone jack and the GAIN control.



Fig. 6 In addition to controlling power on/off, the FUNCTION knob selects calibration, the normal tuning function, or the special +2 tuning circuit which increases the top range by two octaves.



Fig. 7 The CENTS knob and separate pointer has a double function. It's used first for calibration, then the pointer is turned to zero, allowing a variation of half a semi-tone flat to a half semi-tone sharp from correct tuning. Combined with the SELECTOR, this gives continuous coverage.

different frequency for each of the 12 notes, a small amount of time is required to reach a steady speed after the SELECTOR knob is rotated, or after the machine is turned on at first. Only a second or two is required; I mention it only so you'll know it's normal.

Tuning Chorus Organs

Some organs have a separate oscillator for each note of the keyboard, and thus require dozens of tuning adjustments rather than the 12 mentioned before.

With such organs, time can be saved by tuning all the C's, then all the B's, etc. This is possible because the Strobotuner does not require separate settings for different octaves.

Some musicians favor these organs that have separate tuning of each note. It has been said that a pipe organ should never be in perfect tune. Slight variations of the tuning of the individual notes prevent octaves from losing their separate identity. However, we're talking about *tiny* differences. Probably the normal drift of the oscillators or a slight carelessness in setting the frequency is sufficient for most cases.

Tuning Wind Instruments

One potential problem that's neatly solved by the Strobotuner is that many instruments, such as trumpets, oboes, etc., play from "transposed" music. That is, the pitch they play is not the same as that of a keyboard instrument. Trumpets normally tune to B-flat, but that's C on a piano.

Around the SELECTOR dial of the Strobotuner are marked "C", "B-flat", "F", and "E-flat". For keyboard instruments, the note you want must be directly under the "C"; with a trumpet, the desired note must be lined up with the "B-flat", and so on for other instruments.

Of course, those instruments don't ordinarily have electronic pickups, so the sound should come from the microphone.

Guitar Surprises

Tuning keyboard instruments with the Strobotuner was done with speed, accuracy, and confidence; but no surprises. My experiments with guitars brought unexpected

results.

I have never been satisfied that my guitar was ever in tune. Even when tuned carefully against an organ or piano, some chords seemed a bit sour. Perhaps my sense of pitch was good enough to sense the errors of tempered tuning, or the wound strings were requiring stretched tuning.

Now, stretched tuning is something necessary with pianos because many of the strings have smaller lengths of wire wound laterally on them to decrease the natural pitch. Unfortunately, these windings tend to make the upper harmonics sharp in frequency. Therefore, the best tuning of a piano has the bass notes tuned slightly flat and the extreme treble ones tuned a little sharp. A piano tuner who knows **how much** to sharp or flat is a real artist, and certainly is worth his fee.

Anyway, stretched tuning and perfect pitch had nothing to do with the poor guitar tuning. It seems that particular guitar had inherent tuning errors. To produce notes of higher pitch than the "open" strings (ones without any fingers on them), the fingers and thumb are used to press the strings against the metal bars (called "frets"), thus shortening them. Guitars usually are tuned with open strings.

When tuned with open strings against the Strobotuner, the guitar gave the most-pleasing results I ever had. But I continued to want to sharp the top "E" string, to make some chords sound better.

Finally, I checked each string from open to the seventh fret, and found serious errors around the second and third frets. **Now I tune all strings at the third fret, and all chords are in tune!**

Bass guitar

A similar situation occurred with my bass guitar. It seemed to be out of tune all the time. After I received the Strobotuner, I analyzed the tuning of each string and found all four were going sharp as the notes went higher. Finally, I concluded the bridge must be placed wrong. I moved it in steps, checking each time with the Strobotuner, and finally found a spot (more than half an inch from the starting position) where all the notes were in good tune.

Incidentally, all stringed instruments should be tuned with the "C" position of the SELECTOR switch.

Electronic Methods Of Tuning

Perhaps you have been wondering if you could use your audio generator as a standard to tune organs. And what about using frequency counters?

As an electronics man, I have tried to find other ways of tuning instruments, but with limited success. I checked my old, old audio oscillator and found it drifted a couple of semi-tones during a ten-minute period. Modern generators have less drift; however, one tested an A-440 note as about 456 Hz. That's not very close.

Frequency counters can approach the accuracy required. But most are designed for best operation up in the megahertz ranges. They tend to pick up noise and radio signals, adding them to the count. In fact, I have found several counters that go wild when an audio generator is connected. Also, they require a constant amplitude and frequency.

Lissajous patterns on a scope can match two frequencies perfectly; however, with difficulty when the two are not close to each other. But, where can you find an audio source with the required accuracy?

Comments

Electrical frequencies up to about 30,000 Hz can be checked by the Strobotuner. This led me to make some preliminary tests to see if the frequency of vertical and horizontal sweep could be tested with it. Yes, these frequencies can be measured with good accuracy. I intend to explore the subject, and will give a report later, if the results are important.

Using the Conn Strobotuner Model ST-11 to tune musical instruments removes most of the work and worry. Even a tone-deaf technician should be able to tune any organ or other instrument perfectly, after a short time spent in becoming familiar with the Strobotuner.

Extreme accuracy of tuning can be obtained without critical adjustments or difficult judgments. As a person who has tuned many musical instruments, I can recommend the Strobotuner, without reservations. □



Use a screwdriver blade or an alignment tool to hold down one note at a time, when tuning an organ.



A



B

The lowest-numbered arc of strobe lines indicates the octave of the note being tuned. (A) Calibration is done with 60-Hz sine waves from the power line; therefore, few harmonics can be seen at the higher octaves. (B) Notes with strong harmonics show strobe lines of several octaves. The strobe pattern shows only even harmonics, not odd ones. That's why a square wave shows few octaves.



Rhonda Casper demonstrates how to tune guitar open strings with the Strobotuner.

Planning a new service business

...or revitalizing an old one

Part 1

Here's good business advice from the *Small Business Administration's* publication Number 153, plus some editorial comments. It begins with several questions you should ask and answer yourself.

BUSINESS PLANNING— What's In It For Me?

You may be thinking: Why should I spend my time drawing up a business plan? What's in it for me? If you've never drawn up a plan, you are right in wanting to hear about the possible benefits before you do your work.

A business plan offers at least four benefits. You may find others as you make and use such a plan. The four are:

(1) The first, and most important, benefit is that a plan gives you a path to follow. A plan makes the future what you want it to be. A plan with goals and action steps allows you to guide your business through turbulent economic seas and into harbors of your choice. The alternative is drifting into "any old port in a storm".

(2) A plan makes it easy to let your banker in on the action. By reading, or hearing, the details of your plan he will have real insight into your situation, if he is to lend you money.

(3) A plan can be a communications tool when you need to orient sales personnel, suppliers, and others about your operations and goals.

(4) **A plan can help you develop as a manager.** It can give you practice in thinking about competitive conditions, promotional opportunities, and situations that seem to be advantageous to your business. Such practice over a period of time can help increase an owner-manager's ability to make judgments.

Why Do I Want A Business?

Many enterprising Americans are drawn into starting their own business by the possibilities of making money and being their own boss. But the long hours, hard work, and responsibilities of being the boss quickly dispel any preconceived glamour.

Profit is the reward for satisfying consumer needs. But, it must be worked for. Sometimes a new business might need two years before it shows a profit. So where, then, are reasons for having your own business?

Every small business owner-manager will have his own individual reasons for being in business. For some, satisfaction comes from serving their community. They take pride in serving their neighbors and giving them quality work which they stand behind.

There are as many rewards and reasons for being in business as there are business owners. **Why are you in business?**

What Business Am I In?

In making your business plan, the first question to consider is: What business am I **really** in? At the first reading this question may seem silly. "If there is one thing I know," you say to yourself, "it is what business I'm in." But hold on. Some owner-managers go broke and others waste their savings because they are confused about the business they are in.

The recent changeover of barber-shops from cutting hair to styling hair is one example of thinking about what business you're really in.

Consider this example, also. Joe Riley had a small radio and TV store. He thought of his business as a retail store though he also serviced and repaired anything he sold. As his suburb grew, appliance stores emerged and cut heavily into his sales. However, there was an increased call for quality repair work.

When Mr. Riley considered his situation, he decided that he was in the repair business. As a result of thinking about what business he was really in, he profitably built up his repair business and has a contract to take care of the servicing

BOTTOMS



DEALERS' CHOICE

Biggest and best GE Tube Flap Award Program yet.

CHOOSE FROM
63 EXCITING GIFTS OR
THE FABULOUS WORLD OF



Think of 150 gray bottom flaps with the GE monogram as worth 2 full books of S&H Green Stamps. That's like \$6.00 or more at retail. Full details at your authorized GE tube distributor. Use the official entry blank.

Deadline is November 30, 1976.

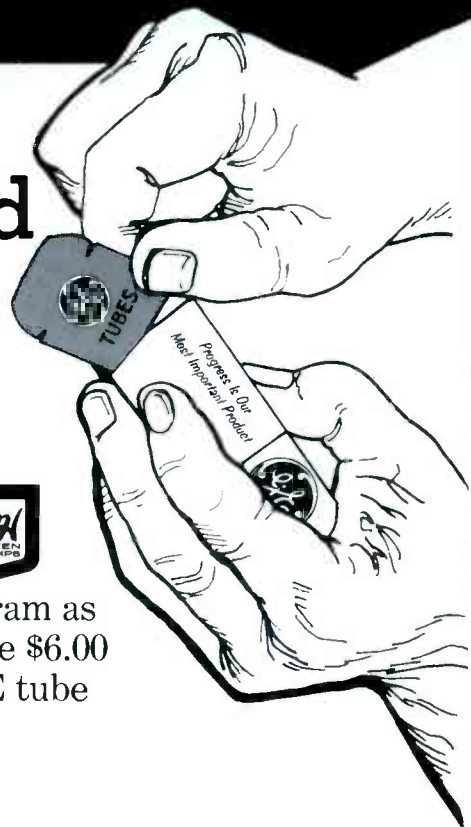

Tube Products Department • General Electric Company • Owensboro, Kentucky 42301

GENERAL  **ELECTRIC**

**Tear
'n
Share**

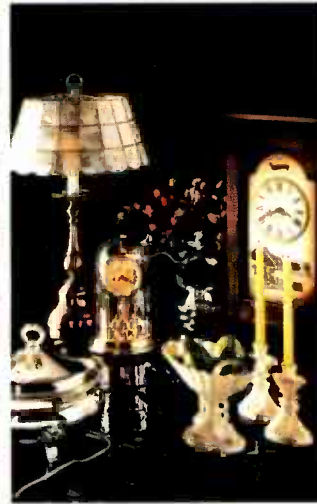

and repair business for one of the appliance stores.

Decide what business you are in, and write your answer. To help you decide, think of the answers to questions such as: What inventory of parts and materials must you keep on hand? What services do you offer? What services do people ask for that you do not offer? What is it you are trying to do better, more of, or differently from your competitors?

Marketing Decisions

When you have decided what business you're in, you have made your first marketing decision. Now you are ready for other important considerations.

Successful marketing starts with the owner-manager. He has to know his service and the needs of his customers in the area he serves.

The narrative and work blocks that follow are designed to help you work out a marketing plan for your firm. The blocks are divided into three sections: Section One—Determining the Sales Potential; Section Two—Attracting Customers; and

Section Three—Selling to Customers.

SECTION ONE— Determining the Sales Potential

In the service business, your sales potential will depend on the area you serve. That is, how many customers in this area will need your services? Will your customers be industrial, commercial, consumer, or all of these?

When picking a site to locate your business, consider the nature of your service. If you pick up and deliver, you will want a site where the travel time will be low and you may later install a radio dispatch system. Or, if the customer must come to your place of business, the site must be conveniently located and easy to find.

You must pick the site that offers the best possibilities of being profitable. The following questions will help you think through this problem.

In selecting an area to serve, consider the following:

- population and its growth potential;

- income, age, occupation of population;
- number of competitive services in and around your proposed location;
- local ordinances and zoning regulations; and
- type of trading area (commercial, industrial, residential, seasonal).

For additional help in choosing an area, you might try the local chamber of commerce, and the manufacturer and distributor of any equipment and supplies you will be using.

You will want to consider the next list of questions in picking the specific site for your business.

Will the customer come to your place of business?

How much space do you need?

Will you want to expand later on?

Do you need any special features required in lighting, heating, ventilation?

Is parking available?

Is public transportation available?

Is the location conducive to drop-

Just Tear and Get your Share.

RCA's Super Prize Program is Back by Popular Demand! As before, just save your RCA entertainment receiving tube carton ends and color picture tube warranty serial number stickers* — to earn valuable awards:

- Lots of great merchandise premiums. Choose from a wide selection for yourself, your family, or your home.

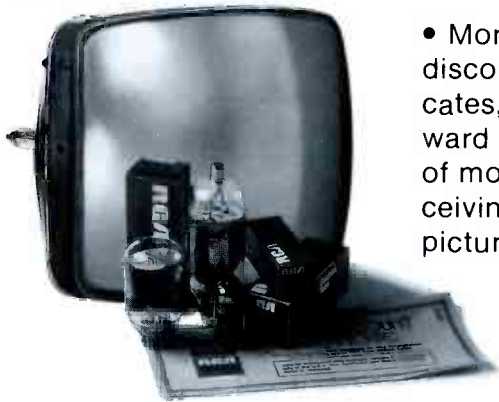

- Money-saving discount certificates, good toward purchases of more RCA receiving and color picture tubes.

Pick up your copy of the RCA "Tear and Share '76" Prize Book, saver envelope and gift order form at your participating RCA distributor. You have until November 30, 1976 to tear 'n share in RCA's bonanza of great gifts. RCA Distributor and Special Products Division, Cherry Hill, N.J. 08101.

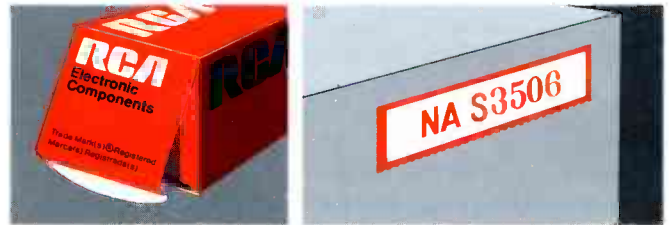

*Save the receiving tube carton end that is *not* marked with the tube type number, and the warranty serial number sticker that appears above the warranty envelope on the upper right hand corner of the color picture tube carton. *One* warranty serial number sticker is equal in value to 20 receiving tube carton ends.

RCA

in customers?

Will you pick up and deliver?

Will travel time be excessive?

Will you prorate travel time to service call?

Would a location close to an expressway or main artery cut down on travel time?

If you choose a remote location, will savings in rent offset the inconvenience?

If you choose a remote location, will you have to pay as much as you save in rent for advertising to make your service known?

If you choose a remote location, will the customer be able to readily locate your business?

Will the supply of labor be adequate and the necessary skills available?

What are the zoning regulations of the area?

Will there be adequate fire and police protection?

Will crime insurance be needed and be available at a reasonable rate?

Is the area in which you plan to locate supported by a strong economic base? For example, are near-

by industries working full time? Only part time? Did any industries go out of business in the past several months? Are new industries scheduled to open in the next several months?

SECTION TWO— Attracting Customers

When you have a location in mind, you should work through another aspect of marketing. How will you attract customers to your business? How will you pull customers away from your competition?

It is in working with this aspect of marketing that many small service firms find competitive advantages. The ideas which they develop are as good, and often better, than those which large companies develop with hired brains. The workbooks that follow are designed to help you think about image, pricing, customer service policies, and advertising.

Image

Whether you like it or not, your service business is going to have an

image. The way people think of your firm will be influenced by the way you conduct your business. If people come to your place of business for your service, the cleanliness of the floors, the manner in which they are treated, and the quality of your work will help form your image. If you take your service to the customer, the conduct of your employees will influence your image. Pleasant, prompt, and courteous service before and **after** the sale will help make satisfied customers—your best form of advertising.

Thus, you can control your image. Whatever image you seek to develop, it should be concrete enough to promote in your advertising. For example, "service with a smile" is an often-used image.

Pricing

In setting prices for your service, there are four main elements you must consider:

- (1) Materials and supplies
- (2) Labor and operating expenses
- (3) Planned profit
- (4) Competition

Further along you will have the

opportunity to figure out the specifics of materials, supplies, labor, and operating expenses. From there, you may want the assistance of your accountant in developing a price structure that will not only be fair to the customer, but also fair to yourself. This means that not only must you cover all expenses, but also allow enough margin to pay yourself a salary.

One other thing to consider. Will you offer credit? Most businesses use a credit-card system. These credit costs have to come from somewhere. Plan for them. If you use a credit-card system, what will it cost you? Can you add to your prices to absorb this cost?

Some trade associations have a schedule for service charges. It would be a good idea to check with the trade association for your line of business. Their figures will make a good yardstick to make sure your prices are competitive.

And, of course, **your prices must be competitive.** You've already found out your competitors' prices. Keep these in mind when you are working with your accountant. If you will not be able to make an adequate return, now is the time to find it out.

Editor's Note: *Several branches of our government are opposed very strongly to any "price fixing". Therefore, you should not copy the prices of another store or shop. You can use a "flat time" schedule that is used also by others, but you cannot use a "flat price" system with other shops. One legal method is to calculate your cost of each hour of labor, for example, and then multiply by the number of hours, either those actually used, or taken from a table of average times. Or, you can decide on flat prices for certain jobs performed, but the price must be based on your costs, and not on a competitor's prices.*

Services to customers

Customers expect certain services or conveniences, for example, parking. These services may be free to the customer, but not to you. If you do provide parking, you either pay for your own lot or pick up your part of the cost of a lot which you share with other businesses. Since these conveniences will be an expense, plan for them.

Advertising

In this section on attracting customers, advertising was saved until last because you must have something to say before advertising can be effective. When you have an image, price range, and customer services, you are ready to tell prospective customers why they should use your services.

When the money you can spend on advertising is limited, it is vital that your advertising be on target. Before you can think about how much money you can afford for advertising, take time to determine what jobs you want advertising to do for your business.

When you have these facts in mind, you now need to determine who you are going to tell it to. Your advertising needs to be aimed at a target audience—those people who are most likely to use your services. Describe your customers in terms of age, sex, occupation, and whatever else is necessary depending on the nature of your business. This is your customer profile. For example, an auto-repair business may have a customer profile of "male and female automobile owners, 18 years old and above". Thus, for this repair business, anyone over 18 who owns a car is likely to need its service.

Now, you are ready to think about the form your advertising should take and its cost. You are looking for the most effective means to tell your story to those most likely to use your service. Ask the local media (newspapers, radio and television, and printers of direct mail pieces) for information about the services and the results they offer for your money.

How you spend advertising money is your decision, but don't fall into the trap that snares many businessmen. As one consultant describes this pitfall: It is amazing the way many businessmen consider themselves experts on advertising copy and media selection without any experience in these areas.

When you have a figure on what your advertising for the next 12 months will cost, check it against what similar stores spend. Advertising expense is one of the operating ratios (expenses as a percentage of sales) which trade associations and other organizations gather. If your estimated cost for

advertising is substantially higher than this average for your line of service, take a second look. No single expense item should be allowed to get way out of line if you want to make a profit. Your task in determining how much to spend for advertising comes down to: How much can I **afford** to spend, and still do the job that needs to be done?

SECTION THREE— Selling To Customers

To complete your work on marketing, you need to think about what you want to happen after you get a customer. Your goal is to provide your service, satisfy customers, and put money into the cash register.

One-time customers can't do the job. You need repeat customers to build a profitable annual sales volume. When someone returns for your service, it is probably because he was satisfied by his previous experience. **Satisfied customers are the best form of advertising.**

If you previously decided to work only for cash, take a hard look at your decision. Americans like to buy on credit. Often a credit card, or other system of credit and collections, is needed to attract and hold customers.

Fixtures and equipment

No matter whether or not customers will come to your place of business, there will be certain equipment and furniture you will need in your place of business which will allow you to perform your service.

Editor's Note: *Make a list of the test equipment you need now. Good test equipment often can save its cost, over a period of time. If you have enough capital, buy all the equipment immediately, instead of waiting. On the other hand, if you have more time than money, you can get by until those extra hours are needed. Write a second list of test equipment you **should have** to operate efficiently. Include a date when you hope to buy each individual piece. Having a target date will help you remember the need, and minimize procrastination.*

Parts and materials

You will need parts and materials to provide a repair service.

List the essential ones, and their costs.

Editor's Note: *Ideally, you should stock every part you will need, and enjoy a fast turnover without waste or obsolescence. Of course, that's impossible. Any other plan is a balancing of costs versus inconvenience to the customers. Perhaps you intend to order all parts (as the need arises) from distributors in other cities. Probably this is the cheapest way to operate, but it can cause customers to become irritated at the long delays. Secondly, if you have an urban location, near several major distributors, you can go there to obtain the parts after you know which are needed. But, there are transportation costs, and wasted time standing in line at the counter. A good compromise is to stock fast-moving items, and pick up those needed less often. Parts kept in stock cause expenses, also, and tie up capital. Good management consists of finding the best compromise between stock and special orders. Examine your methods every month or so, to prevent losses from continuing too long.*

Now that you have determined the parts and materials you'll need, you should think about the type of stock control system you'll use. A stock control system should enable you to determine what needs to be ordered on the basis of: (1) what is on hand, (2) what is on order, (3) what has been used. (Some trade associations and suppliers provide systems to members and customers.)

When you have decided on a system for stock control, estimate its cost.

Overhead

List the overhead items which will be needed. Examples are: rent, utilities, office help, insurance, interest, telephone, postage, accountant, payroll taxes, and licenses or other local taxes. If you plan to hire others to help you manage, their salaries should be listed as overhead.

Next Month

Delegating work and responsibility, translating your business plan into dollars, the break-even point, and updating your plan are subjects to be covered next month.



MEET OUR FAMILY of High VOLTAGE TEST PROBES

In 1967 we introduced the first high voltage test probe with a built-in meter. It became so popular that we have been adding new models ever since. Now there are five different versions to satisfy the demands of radio, television, appliance, audio, and electrical repair men in a wide variety of high voltage testing applications.

The five models are briefly described below. Our general catalog contains complete applications information, illustrations, specifications, and prices. Write for your free copy.

MODEL 4242—42,000 volts DC.
Negative ground.

MODEL 3157—15,000 volts DC.
Negative ground.

MODEL 4312—15,000 volts DC.
Positive ground.

MODEL 3163—6,000 volts DC.
Negative ground.

MODEL 3200—10,000 volts AC.

AVAILABLE THROUGH YOUR
FAVORITE ELECTRONIC PARTS DISTRIBUTOR



ITT POMONA ELECTRONICS

1500 East Ninth St., Pomona, Calif. 91766
Telephone (714) 623-3463, TWX: 910-581-3822



SCOPING CB CARRIERS

By Marvin J. Beasley, CET, Land Mobile Regional Manager, E. F. Johnson Company



Some of the equipment used to show the advantages of an RF scope for CB work include: (at the left) my old Drake communications receiver, with an IF connection for a scope; a Tektronix Model T932 dual-trace 35-MHz scope (in the center); below the scope is a Johnson Messenger Model 132 CB transceiver; (at right below) a B&K Model E310B audio generator; and a Pace Model P5430 CB tester (at right above).

Some new scopes have the bandwidth and sensitivity to observe 27-MHz carriers. This article explains many of the unique and valuable uses for RF scopes in servicing CB radios.

Why Use A Scope?

Over the years, oscilloscopes have not rated high on a list of essential test equipment for servicing two-way or CB radios. Most scopes had high-frequency responses ending at about 5 MHz, which certainly would not permit direct viewing of a 27-MHz carrier. A few lab-type

scopes had sufficient bandwidth, but the price tags were too high for any service shop.

In addition, many technicians didn't believe any scope could be very useful. "Why should I look at a carrier? It's nothing but sine waves anyway." "You can hear distortion, a scope isn't needed." These were some of the opinions.

Well, new scopes with 35-MHz bandwidth and reasonable prices now are available. That cancels all of the objections except the question: "What good is a scope for testing radio transceivers?" We hope to explain the value of scope operation.

The Radio System

A complete radio system (Figure 1) consists of a radio transmitter with audio modulation, and one or more radio receivers for processing the modulated signal and recovering the original modulation. Theoretically, the audio output from the receiver should have exactly the same waveshape, without any added noise, hum, or distortion.

In practice, this ideal is not possible. What's more, with CB operation it's not desirable to have unlimited bandwidth. Low frequencies are attenuated to minimize hum, and the high frequencies are rolled-off to reduce the audible

effects of noise. Also, the intermediate-frequency (IF) bandwidth in the receiver must be made very narrow to reduce interferences from other CB channels. This narrow IF response virtually eliminates the audio high frequencies.

However, under favorable conditions, the audio-output waveform at the receiver can be a good replica of the original audio (see Figure 2).

A scope certainly is the fastest test instrument to detect distortions of these waveforms. Before showing the advantages of viewing 27-MHz RF carriers, let's review some valuable jobs that even conventional scopes can do.

Average Modulation

Amplitude modulation of a CB transmitter means that power from the modulator circuit alternately increases and decreases the power (amplitude) of the RF carrier. Higher modulation tends to raise the desired audio above any noises or interferences. Therefore, you'd think that a huge amount of modulation would be desirable. That's true, up to 100% modulation (Figure 3, where the positive peak of the audio has doubled the carrier amplitude, and the negative peak has reduced it to zero).

The problems start when the modulation is increased above 100%. The audio peak which reduces the carrier power now tries to produce **less than zero carrier power!** Since that is impossible, the result is a time of zero carrier (see Figure 4). In the receiver, following detection, the period of zero carrier appears as a flat top of the audio waveform. To say it another way, excessive negative modulation produces clipping of the audio waveform. Clipping adds harmonics which were not there originally, making the voice sound harsh and distorted. Worse yet, the harmonics generated by the clipping causes the carrier to splatter over into the next CB channel.

There's no problem with splatter during the audio peak that increases the carrier power. However, it's possible for the modulator or the modulated RF stage to suffer damage or arcs because of the excessive voltages. Or the modulator might distort and flatten a peak.

For all these reasons, a high

modulation is desirable, but it should never exceed 100% (where the carrier disappears).

Speech patterns

Unfortunately, human speech (Figure 5) is not constant in amplitude. Some sounds have amplitude

peaks out of all proportion to their contribution to intelligibility. How is it possible, under these conditions, to keep the average modulation high (to override the noise) without exceeding the 100% point? Either of two electronic methods can be used in the transmitter:

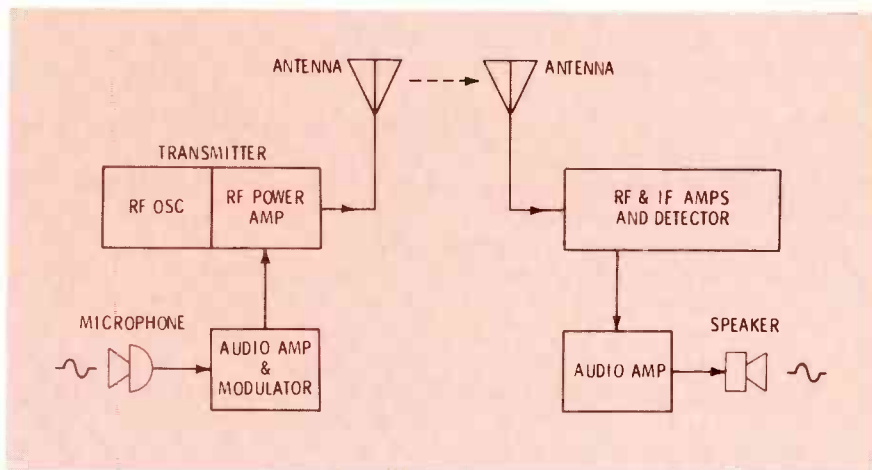

Fig. 1 Radio transmitters and receivers have both audio and RF circuits. A scope with a high-frequency response beyond 27 MHz can show a waveform of almost every stage.

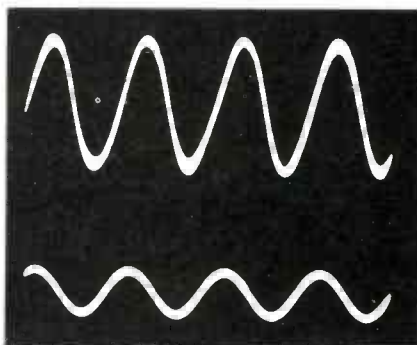

Fig. 2 CB operation can produce undistorted audio. The bottom trace shows the generator sine waves used to modulate a transmitter, and the audio recovered from another receiver is at the top.

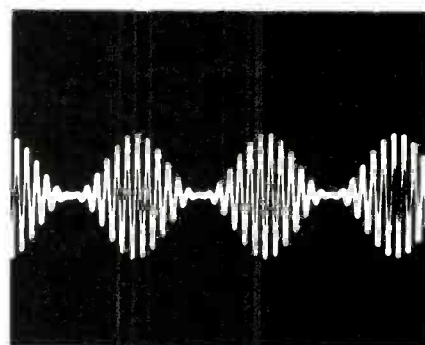
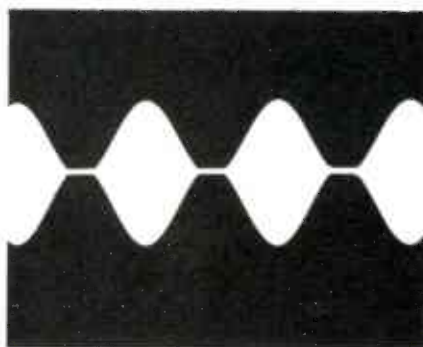
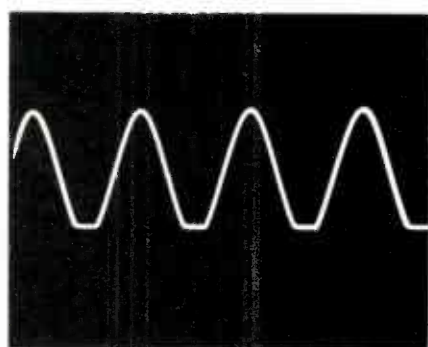

Fig. 3 This is 100% amplitude modulation, simulated by use of a function generator, which shows how the carrier sine waves change in amplitude.



A.



B.

Fig. 4 Overmodulation produces areas without any RF carrier (A). Following detection in a receiver, these zero-RF areas become flat tops or bottoms of the audio waveform (B).

audio compression or clipping.

Compression

Average modulation can be kept high by a compression circuit which acts to decrease the gain when the audio signal voltage increases too much. The circuit must be worked out carefully, however, or else fast gain reduction could cause clicks or thumps. Also, a too-slow reduction of gain would allow the first part of each word to be distorted.

Clipping

Clipping of both peaks above a certain amplitude operates instantly to prevent overmodulation, but precautions must be taken to minimize the distortion that results. Figure 6 shows what happens to a sine wave as the level is increased. Ideally, the peaks are clipped at about 90%, so the modulation can never exceed 100%.

Unfortunately, this audio clipping produces sharp corners and flat tops which indicate that harmonics are generated. These extra harmonics would cause audible distortion and splatter over adjacent channels, if not eliminated.

Because CB radio does not need wide-band frequency response, a solution for the distortion is to use a one-stage or two-stage resistance-capacitance low-pass filter to round the corners of the clipped waveform, as shown in Figure 7. Such filters usually roll-off above 2500

Hz. The missing frequencies are not noticed, because they would have been eliminated by the sharp IF bandpass of the receiver, if they had been broadcast.

Power mikes

Modern, deluxe CB transceivers do not need an amplified (power) microphone. Adding one often results in serious overmodulation, producing splatter and a loss of intelligibility.

However, a few "economy" models are capable of only about 50% modulation, even if you shouted into the mike. Those kinds (and only those) benefit from a power mike.

Some power mikes have gain and clipping controls. Therefore, if a certain CB radio has insufficient audio gain without clipping, the addition of a power mike can be helpful.

A scope provides the most accurate and rapid way of adjusting the clipping level.

Any scope for audio

I recommend a scope for any kind of troubleshooting in the audio stages, because of the speed and accuracy of the tests.

Probably the best method is to feed a sine-wave signal from a generator into the mike jack through a loss pad (which reduces the level to that of a mike). Starting there, follow the signal through

each audio stage in turn, using the scope to notice where the waveform changes. Then use tests such as voltage, resistance, or transistor checks to identify the bad component.

TV Scope For Receivers

Some information about over-the-air signals can be obtained by connecting a TV-service scope (4-MHz or better bandwidth) to the IF circuit of a test receiver. Usually it's connected just before the audio detector, as shown in Figure 8.

When connected that way, a scope shows the approximate amount of modulation (Figure 9), and some kinds of distortion (see Figure 10).

Certainly, this kind of troubleshooting is helpful, but there are definite limitations. First, you're testing **both** a transmitter and your own receiver. How can you be certain which one is causing any specific problem?

A receiver can add distortion, or it can minimize the sharp corners of transmitter clipping. Even if the receiver had perfect linearity, the sharply-tuned IF section would restrict the bandwidth to about 3 KHz, and that rounds the corners of any transmitted waveform. Imperfect linearity might change the percentage of modulation.

Scope for signal tracing

A TV-service scope with high

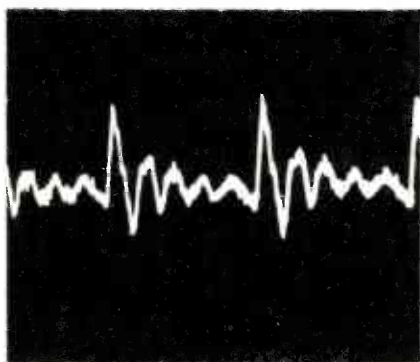

Fig. 5 Human speech waveforms change constantly, although this one is typical of male voices. It is a saw-tooth waveform with ringing. If the gain is turned high to override the noise, the tall peaks often overmodulate. A compressor reduces the total amplitude without changing the wave-shape very much, while a clipper makes all parts of the waveform nearly the same height.

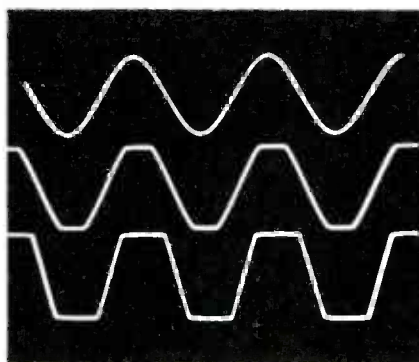

Fig. 6 Here's an illustration of audio clipping. When the audio level is below the clipping point, the waveshape is not changed (top trace). Clipping of the tips of the positive and negative peaks occurs when the level is increased (center trace). When the input level is increased again (trace at bottom), the peak amplitude is not increased, but more of the waveform is clipped. This causes distortion, but prevents overmodulation.

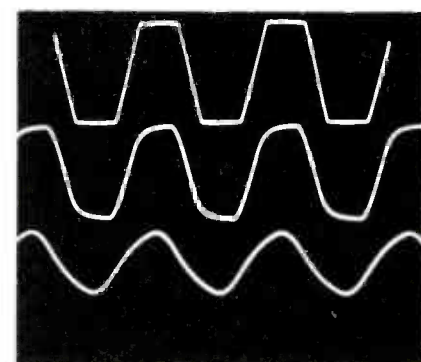

Fig. 7 Low-pass filters (used after the clipping) remove most of the sharp corners (high-frequency harmonics), thus minimizing distortion from audio clipping. Top trace is the sine-wave signal with severe clipping. The effect of one RC low-pass filter is shown in the center; and two cascaded filters nearly restore the sine wave (bottom trace).

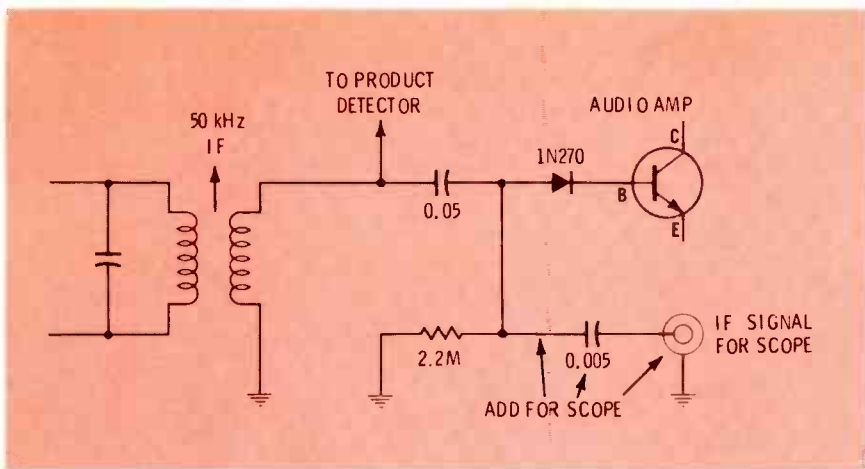

Fig. 8 The Drake receiver has been modified for scope operation by adding a coupling capacitor, connecting wire, and an output jack. Keep the length of wires short, if you prepare a test receiver this way.

sensitivity can be used to signal-trace a receiver in each IF stage, and through the audio to the speaker. The IF's never are above 455 KHz, and that's well within the passband of such a scope. However, a 35-MHz scope can see the signal at the collector of the RF transistor! We have pictures of the waveforms there, but they are similar to ones already shown. But that's getting ahead of our story.

Measuring Modulation

There are two main methods of measuring the amplitude modulation percentage of an RF carrier; they are shown, with formulas, in Figure 11.

Both methods require a scope vertical response that's flat up to the carrier frequency. With older scopes, it was necessary to connect the RF direct to the scope plates, bypassing the internal amplifiers. This posed some problems in obtaining the right amount of RF.

The second method had the additional drawback of requiring a sample of the audio modulation signal to drive the horizontal sweep of the scope.

Tests With A 35-MHz Scope

Modulation and signal-tracing tests are easier and more accurate with a scope, such as the Tektronix Model T932, which has a 35-MHz bandwidth (see Figure 12).

It's fascinating to see the individual cycles of an unmodulated 27-MHz carrier, when they are spread out across the scope screen as though they were audio sine waves (Figure 13).

But, there's a serious purpose behind viewing each individual cycle. The **time duration** of each sine wave cycle can be calculated to yield the approximate frequency. This is easy when you use a triggered scope and a calculator.

Time versus frequency

The formula for time versus frequency is very simple: frequency equals the reciprocal of the time of one cycle. For audio it is: frequency in Hertz equals the time of one cycle expressed in seconds divided into 1. A variation of that is more convenient for RF work: the frequency in megaHertz equals 1 divided by the time of one cycle expressed in microseconds.

For example, with a scope horizontal sweep time setting of .1 microsecond per centimeter, a sine wave that occupied just one centimeter would have a frequency of approximately 10 megaHertz.

At 27 MHz, each cycle is .37 centimeter wide on the scope screen, at a sweep time of .1 microsecond. That's 2.7 sine waves per centimeter, or about 27 for the entire scope screen. But the Tektronix T932 has a variable sweep-time control, giving up to 10 times the effective width of each cycle. So, at maximum, the scope screen shows less than three cycles. Such performance is excellent.

Of course, measurement of frequency by this means is not accurate enough to determine the exact carrier frequency. Instead, the value is in being able to determine very rapidly the approximate fre-

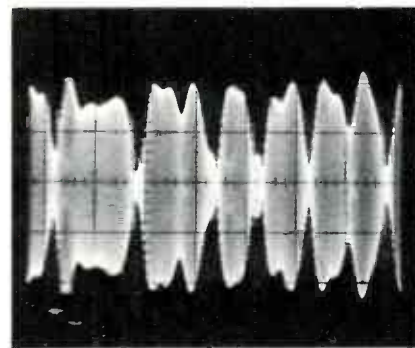

A.

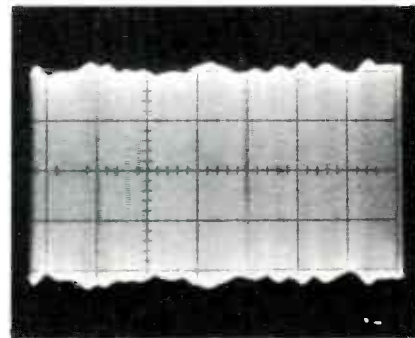

B.

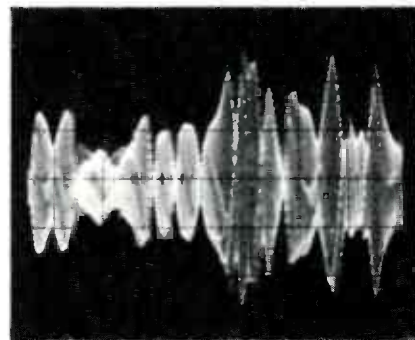

C.

Fig. 9 These are examples of GB signals obtained from the IF of a GB receiver (A) Good-quality, high-modulation signal; (B) carrier with very low modulation; and (C) a single-sideband carrier. With SSB, the carrier disappears between words (when there's no audio).

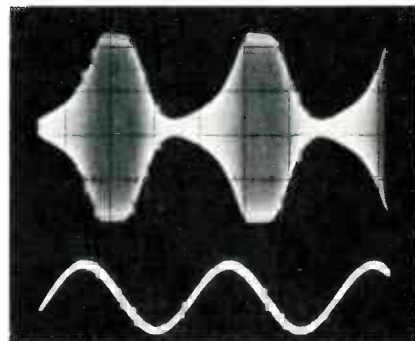

Fig. 10 An attempt to reach 100% modulation with one defective radio provided these waveforms. The input audio was undistorted (bottom trace), but the RF carrier (observed at the IF of a receiver) showed flat-topping and other distortion.

quency of doublers, and for locating a stage that is self-oscillating, or tuned circuits adjusted to the wrong harmonic.

Signal tracing RF

No problems were caused by

loading or detuning of the solid-state circuits by the X10 probe and T932 scope. The probe did not kill the oscillator, nor noticeably detune the resonant circuits in either the transmitter or receiver sections.

This scope can be used as an RF

voltmeter, with the advantage that you can see the waveform at the same time. Of course, all scopes are calibrated in peak-to-peak, so you must multiply the scope reading by .707 to obtain the RMS voltage that is included with many schematics.

AMPLITUDE MODULATION

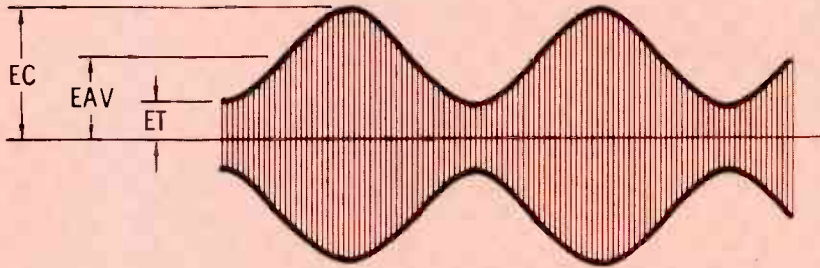

$$\text{MODULATION \%} = \frac{EC - ET}{2EAV} \times 100 \quad \text{OR} \quad \text{MODULATION \%} = \frac{EC - ET}{EC + ET} \times 100$$

WHERE: %M IS THE PERCENTAGE OF MODULATION
 EC IS THE AMPLITUDE OF THE CREST
 ET IS THE AMPLITUDE OF THE TROUGH
 EAV IS THE AVERAGE AMPLITUDE

A.

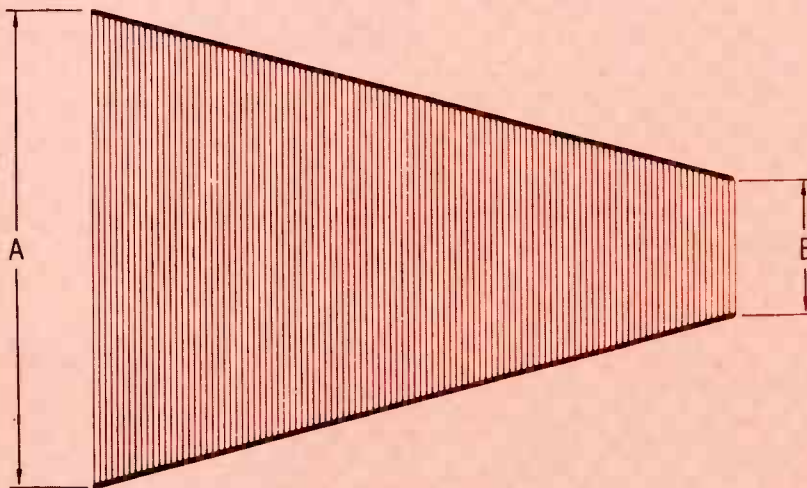

$$\text{MODULATION \%} = \frac{A - B}{A + B} \times 100$$

B.

Fig. 11 The percentage of modulation can be determined with a scope by two basic methods. (A) Horizontal sweep is provided by the scope, and modulated RF supplies the height. With method (B), the audio modulation provides the horizontal sweep, and the modulated RF supplies the height. The latter method requires more time and trouble to perform, but it gives a more positive indication when 100% is reached (the trapezoid comes to a point), and the straightness of the sides shows linearity.



Fig. 12 With a Tektronix Model T932 scope, one channel can be connected direct to the 27-MHz modulated RF output signal (top trace), while the other channel shows the audio recovered by another radio.

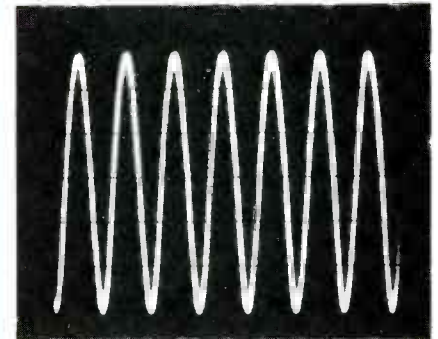

Fig. 13 An unmodulated 27-MHz carrier can be viewed on the T932 in the same way as an audio signal is displayed on a conventional TV scope.

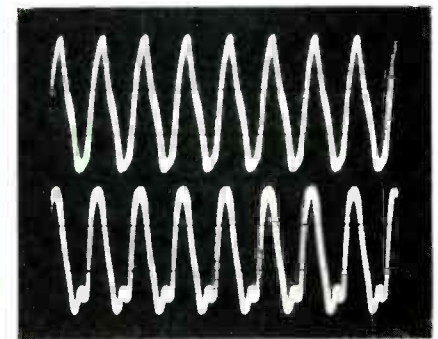

Fig. 14 These waveforms were found in a frequency-synthesizer circuit, proving that the T932 will show some 27-MHz distortion, even though the frequency is near the scope's cut-off point.

DC voltage can be measured, also. There are several methods. Perhaps the easiest, when you are looking at a waveform having a DC component, is to change from AC to DC coupling and count the number of graticules the waveform moves. For example, if the range is 1-volt-per-CM, and the waveform moves three centimeters, the DC voltage is 3 volts.

Distortion at 27 MHz?

A low-pass filter, which removed all harmonics, would have sine waves only at the output, regardless of the waveshape of the input signal. Therefore, it is proper to ask if the T932 can show anything **except** sine waves at 27 MHz; the second harmonic is 54 MHz, which is above the top limit of the bandwidth. The waveforms of Figure 14, found in a frequency synthesizer, prove that **some distortion does appear**. This adds to the value of the scope when used for RF servicing.

Direct Versus Receiver Tests

We have shown you how to modify a CB receiver, permitting a TV-service scope to show modulated-carrier waveforms. A natural question is this: What is the advantage of using a 35-MHz scope to examine directly the amplitude-modulated RF carrier of a CB transmitter, compared to viewing the same carrier indirectly in the IF circuit of a test receiver? Well, it's the only way you can be certain the waveform is correct, and that the test receiver has not removed from, nor added to, the waveshape.

Figure 15 shows several examples of normal and wrong waveforms in actual CB radios. Think of the hours you might have wasted, if you had tried to diagnose some of these conditions without a wide-band RF scope!

Comments

After using the T932 for just a few days, I'm convinced an RF scope should be in every well-equipped CB repair shop. For example, the scope can be used as a visual voltmeter to tune circuits, or to measure the level of signal. Where before I would check modulation with some good brand of meter (such as a Pace P5430), now I use **both** meter and scope. A

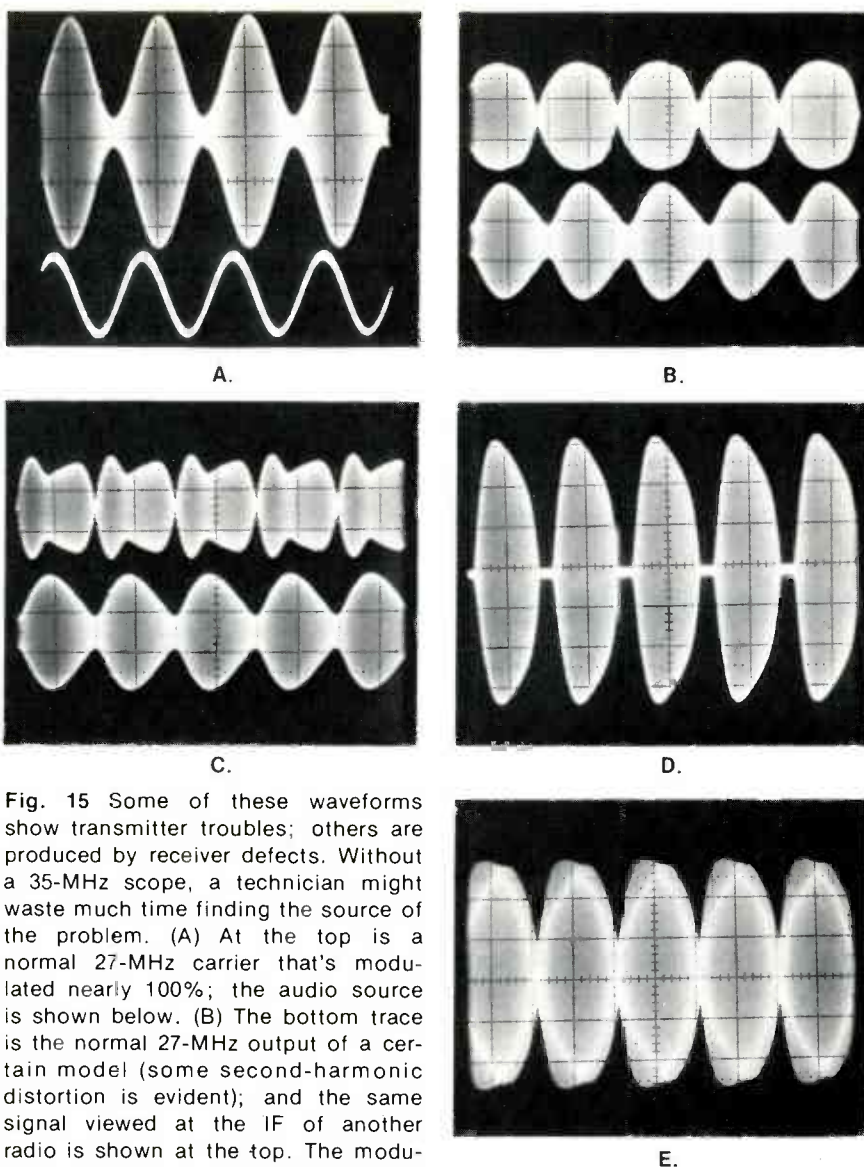

Fig. 15 Some of these waveforms show transmitter troubles; others are produced by receiver defects. Without a 35-MHz scope, a technician might waste much time finding the source of the problem. (A) At the top is a normal 27-MHz carrier that's modulated nearly 100%; the audio source is shown below. (B) The bottom trace is the normal 27-MHz output of a certain model (some second-harmonic distortion is evident); and the same signal viewed at the IF of another radio is shown at the top. The modulation has increased, and the distortion is so bad that the detected output would be nearly parabolic in shape. (C) Another receiver had a notch in the IF alignment curve, causing the distorted top trace; the bottom trace is the 27-MHz transmitter carrier for comparison. (D) When the mike gain was increased gradually, one CB radio

modulation meter can give inaccurate readings when the signal is distorted heavily; so, I use it for general percentage levels, and change to the scope for tests of quality.

The Tektronix T932 dual-trace 35-MHz scope handled perfectly all the tests I tried. One outstanding feature was the extreme brightness of the trace, which was possible because of the accelerating-anode voltage of 12 KV.

Other scopes of the T900 series include the T931 single-trace 35-MHz version, and two 15-MHz

suddenly produced this overmodulated pattern. Distortion and splatter would result, if an operator attempted to use it in the usual way. (E) This unstable, double pattern was caused by a lack of shielding when the case was removed from a receiver that was near the transmitter.

models in single-trace and dual-trace (these latter models were described in Test Equipment Report on page 53 of the November, 1975 issue of ELECTRONIC SERVICING).

In summary, I strongly recommend that you use a scope having a vertical bandwidth exceeding 27 MHz for the repair and adjustment of CB transceivers. It is certain to reduce the time you spend during such repairs, and probably you will discover many more uses for this versatile instrument than the ones I have mentioned here. □

SERVICING RCA XL-100



Part 7/By Gill Grieshaber, CET

You need MORE than a caddy of modules, if you want to make a profit repairing the new color-TV receivers. To prevent wasted time, you should know where the important testpoints are located, and what waveforms or DC voltages should be there. Continuing with the RCA CTC58 chassis, we explain how to find terminal #1 of all modules, and give some troubleshooting methods using the testpoints.

"A technician should be able to fix any new color TV in 15 minutes by plugging in modules." Do you believe that statement? Well, I certainly don't. Of course, if there is only one trouble in one module, then a modular TV **could** be repaired that easily. But let me point out some examples where module replacement does not help; and, in fact, might ruin more components.

One defect leads to another

Using the RCA CTC58 as our example, suppose one of the vertical-output transistors shorted out. Usually the other output shorts, too, burning up R604 (See page 35 of December, 1975 ELECTRONIC SERVICING). Other components on the MAG001B vertical module (such as Q3 driver or CR4 zener)

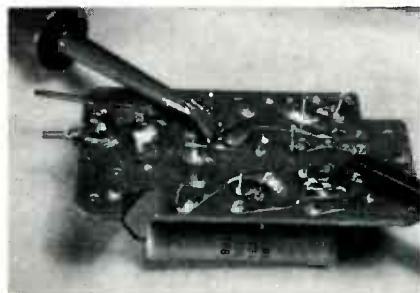

Probes with hooks that withdraw inside the insulated handle are ideal for use on crowded boards to prevent accidental shorts. At the upper left is a Pomona probe, and the one at the right is a B&K scope probe. Solder a short right-angle piece of wire to the wiring side for a safe, solid connection, as shown here on a MAD001A module.

might have failed because of the same overload.

Now, suppose you merely replace the MAG001B module. Is the vertical sweep going to operate? Obviously not. What's more, some components of the new module might be damaged during the test.

Also, the vertical-height and vertical-hold controls are not on the module. Several interesting cases have come to light indicating module trouble, yet the defect was around the hold control.

To complicate matters, the total vertical sweep circuit is scattered all over the chassis. Besides the module, the output transistors and three base diodes are mounted on a heat sink underneath the yoke. R604 is on the PW600 power supply board, the hold control and resistors are at the bottom of the main metal chassis, the output coupling capacitor is on the PW400 board near the module, and the output signal goes through both the pincushion-correction and convergence circuits on its way to the yoke.

We could go on and on with examples (such as finding video signals in a total of **five** modules), but I think the point has been made. You need much more than a caddy of modules to repair some of these new TV receivers. That's why we have given so much information about the way various circuits work.

Don't guess

Yes, even with modular receivers, you need to know (or be able to **find easily**) the locations and functions of many components and test-

points. There are dangers in fumbling around by guesswork. Remember: solid-state components cannot tolerate serious overloads, even for a split second; it is their worst fault. An accidental short can zap a transistor before you realize the mistake.

This susceptibility to damage becomes even more important and dangerous because of the crowded connections and components in modern wiring. **One minor slip of a test prod can ruin many solid-state devices!**

Solving the problem must be done in two ways. The first necessity is a Photofact (or manufacturer's service data) for the receiver you're working on. Second, all test connections must be dependable, without danger of shorts to any adjacent component. One solution is to use tiny insulated hook-type test prods.

Finding Testpoints

The best testpoints are those for DC-supply voltages, input signal, and output signal; those that reveal the performance of entire circuits, not just the individual stages. For example, with AGC we need to know where to find the keying pulses, video detector, IF AGC, and RF AGC testpoints.

AGC voltages

Positive-going keying pulses were measured at terminal 10 of the MAK001B module (see Photofact 1428-2), and the tuner AGC (true to RCA tradition) was at the green wire going to the tuner. But finding

the IF AGC and the output of the video detector became a problem, because they have no connection to the outside of the module.

Inside ICI were the transistors for the complete IF circuit, the AGC keyer, unknown components to produce both IF and RF AGC, and the video detector. To make matters worse, the entire MAK001B module has shielding on all sides; and some IF's become unstable or oscillate if the shielding is removed. What to do?

After studying the Photofact and the chassis for a time, I decided one of the side shields could be removed, permitting access to the points I wanted. AGC for the IF was found at C16 (Figure 1), and the output of the video detector drives the base of Q2, the video preamp transistor. Also, the video comes out of the module at terminal 8. (Chroma is taken from the same point, but through coupling capacitors and the take-off coil, finally emerging at terminal 7.)

Next, I measured the DC voltages at those points, both with a strong signal and with none, and made up this AGC chart:

	Strong signal	No signal
RF AGC	+1.9V	+5V
IF AGC	+1.95V	+2.3V
Q2 base	+4V	+6.5V
Q2 emitter	+4.7	+7.2V

These voltages provided me with typical DC voltages for the AGC circuit both with signal and without signal, and also proved the video detector was negative-going (sync on bottom of waveform), and that both RF and IF AGC operated by reducing the forward bias (cutoff bias).

If I suspect AGC problems in another CTC58, I will refer to these voltages and use them as standards. For example, an AGC overload producing excessive detector signal, but RF and IF AGC suitable for a weak signal indicates an AGC problem (likely in ICI). On the other hand, IF AGC typical of a strong signal and RF AGC for a weak signal might indicate a tuner problem. Not all AGC components (such as the noise control, etc.) are on the MAK module, and the circuit has no AGC control. Therefore, these facts and voltages are needed for proper and speedy

analysis of any AGC problems.

Module terminal numbers

The terminal numbers are not marked on any of the modules. All modules, except MAA001A sound module, have wiring on both sides of the board and terminal contacts on the component side only. This might have been helpful in locating terminal 1 of each module, except not all are inserted with the components facing the same direction.

Finally, I noticed that the top terminal is #1 for all modules except MAN002B, MAK001B, and MAH001A, which have #1 at the bottom (MAB003A, power supply module, has #1 at your right, as you face the rear of the chassis).

Most modules have two separate sockets, with differences in either the module or socket so the module cannot be plugged in upside down. MAK, the IF module, has three sockets, and the MAD modules have only one each. Again, MAA001A is the maverick, because it can be plugged in upside down, if you work at it.

Most modules have spring clips that seat in a groove to keep the module from falling out (of course, the sockets fit very snugly, too). Hold the springs back out of the way, when you remove a module. Also, brace the "mother" board to prevent any damage while you insert a module.

If you employ moderate care while removing or installing modules, and don't use spray chemicals on the sockets or contacts, you should have few troubles with bad connections.

Tracing The Video

Four stages of video are employed. The MAK001B IF/AGC module has the video detector, and the video preamplifier, which is wired as an emitter follower. MAL001B has two stages of video. First is the delay line (Figure 2), followed by Q3, the first video amplifier. A degenerative-type contrast control varies the amount of video at the emitter of Q3 (see the partial schematic of Figure 3), while both horizontal and vertical blanking is injected at the collector. Q3 is wired as a common-emitter amplifier, so it does have a small amount of gain, as it inverts the phase.

Figure 4 shows ten waveforms, covering all major points between the video detector and the picture tube. Notice the radical change of waveform occurring between the base of Q3 and its collector. That's because of the vertical and horizontal blanking, which make the following waveforms unlike classic



Fig. 1 IF AGC voltage can be measured at the outer end of C16 (shown in front of the forefinger). The IF AGC does not emerge from the MAK001B module.



Fig. 2 The delay line on module MAL001B makes a good video test point. It is prior to insertion of vertical and horizontal blanking, so the video there can be examined for hum or compression.

COST EFFECTIVE COMPONENTS

May Special
IC ASSORTMENT
25 COMMONLY USED
IC FOR TV AND STEREO
Assortment \$22.50

C.E.C.'s First Line Transistors

CEC	TR01	Equivalents		GE	
		ECG	RCA		
	TR01	162	SK3079	—	\$3.45
	TR02	123	SK3122	61	.34
	TR03	159	SK3114	67	.34
	TR04	152	SK3041	14	.75
	TR05	241	—	—	1.30
	TR06	197	SK3085	—	1.90

ICs	IC01	Equivalents		IC04	5 for	
		ECG	RCA			
	IC01	714	SK3075	IC04	5 for	\$4.50
	IC02	731	SK3173	—	5 for	4.50
	IC03	713	SK3077	IC05	5 for	4.50
	IC04	790	—	—	5 for	4.50
	IC05	712	SK3072	IC02	5 for	4.50
	IC06	709	SK3135	IC11	5 for	4.50
	IC07	710	SK3102	—	5 for	4.50
	IC08	725	SK3162	—	5 for	4.50
	IC09	718	SK3159	IC08	5 for	4.50
	IC10	720	SK3160	IC07	5 for	4.50
	IC11	723	—	—	5 for	4.50
	IC12	—	—	—	5 for	6.00

C.E.C. Specials

160 MFD 250 VDC Filters 1"	10 for \$9.00
160 MFD 250 VDC Filters 1-3/8"	10 for 11.00
Japanese transistor kit 20 most popular	8.25
Miniature electrolytic kit 25 popular types	8.25
72 ohm to 300 ohm Matching Transformer	10 for 6.50

ICs	Zenith numbers	ICs	Zenith numbers
221-31	5 for \$4.50	221-52	5 for 4.50
221-32	5 for 4.50	221-62	5 for 4.50
221-34	5 for 4.50	221-65	5 for 4.50
221-42	5 for 4.50	221-79	5 for 4.50
221-45	5 for 4.50	Delco numbers	
221-46	5 for 4.50	DM-11	5 for \$4.50
221-48	5 for 4.50	DM-31	5 for 4.50
221-51	5 for 4.50	DM-54	5 for 4.50

We also stock new and used ultrasonic cleaners.

Minimum order \$25.00.
We pay shipping.

C.E.C.

Cost Effective Components

P.O. Box 1965, Burlingame, CA. 94010.
415/344-6383

video. The continuous line above the horizontal-blanking pulses is produced by the vertical blanking.

Brightness control

The entire video circuit is direct coupled, and the brightness of the picture tube is controlled by variation of the base voltage of Q4 on the MAL001B module. A partial schematic of the circuits between the base of Q4 and the picture tube is given in Figure 5.

At first glance, the brightness circuit seems simple. Q4 is wired as an emitter follower (the emitter should have nearly the same AC and DC voltages as the base). And CR4 appears to be a gate, letting voltage through only when the cathode is less positive than the anode.

However, CR4 is more than a mere gate. As the brightness control is varied from very bright to dark, the DC voltage across the diode is **reversed bias** changing from about 2-volts DC to 4-volts DC.

If CR4 functioned either as a voltage regulator or as a gate, the anode certainly would be more positive than the cathode. No, CR4

is a DC restorer that rectifies the video and blanking signals, and so produces a negative voltage that subtracts from the positive bias brought in by R14.

In any event, the base voltage of Q4 does change with adjustment of the brightness control (and also with action of the brightness limiter, which is connected to the circuit). Positive voltage at the emitter of Q4 (brought in by R330 and R114) is varied by the emitter current. When Q4 draws less current, the emitter voltage rises, which through the video drive control also increases the positive voltage at the emitter of the video output transistor on the MAD001A module. This is less forward bias for the output transistor, so the collector voltage rises. The collector is connected to one cathode of the picture tube, thus decreasing the CRT current and the brightness of the screen. Of course, if the base voltage of Q4 becomes less positive, all those actions are reversed, and the screen becomes brighter.

Chroma Signals

Tracing any kind of signal
(Continued on page 36)

Here's a brand-new group of fashion antique reproduction belt buckles...your Free Bonus with this money saving Color-Brite offer

Antique reproduction brass belt buckles are all the rage...so we are giving you another chance at one of our all time favorite bonus offers. We've selected four of the most wanted designs-Liberty, Anheuser Busch, Indian Head, and Ford Automobiles. They normally sell for \$5.95 or more, and fit most belts. You get one free with each package of four Model C-511 Color-Brites, and save over \$1.00 a britener besides. Model C-511 Color-Brites are the briteners you need most often. They immediately improve sharpness, detail, and contrast of faded color pictures, and they fit most sets.

This repeat offer is valid only while belt buckles supplies last. Hurry to your distributor today!

Perma Power

Chamberlain Manufacturing Corporation
 Perma Power Division
 5740 N. Tripp Avenue • Chicago, Illinois 60646
 Telephone (312) 539-7171

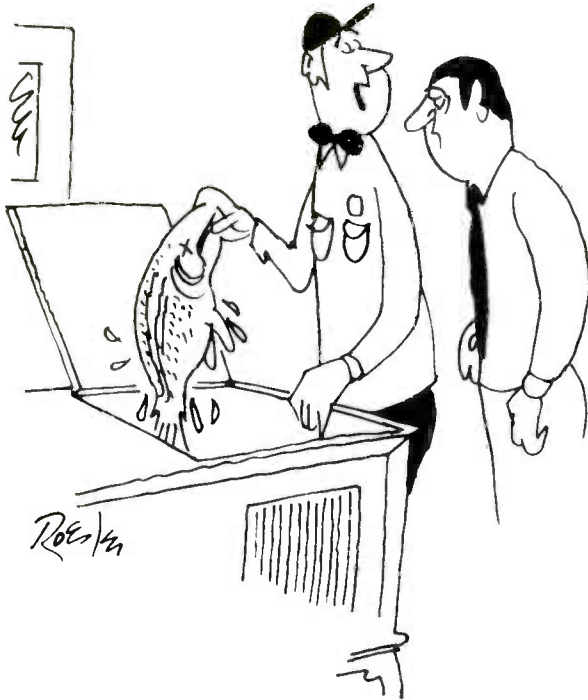

"Here's your trouble—too much bass!"

Checklist of Books for Electronic Technicians!

- Modern Electronics Math 686 p. 424 il. \$9.95
- How To Repair Home Laundry Appliances 280 p. 137 il. \$5.95
- Modern Guide to Digital Logic 294 p. 222 il. \$6.95
- Build Your Own Working Robot 238 p. 83 il. \$5.95
- Master Hdbk. of 1001 Pract. Electr. Circ's 602 p. 1250 il. \$9.95
- T shooting with the Dual-Trace Scope 224 p. 252 il. \$5.95
- Microprocessor Microprogramming Hdbk 294 p. 226 il. \$6.95
- Impedance 196 p. 90 il. \$5.95
- Op Amp Circuit Design & Applications 280 p., 239 il. \$6.95
- Build-It Book of Miniature Test Meas. Instr. 238 p., 151 il. \$4.95
- Digital Logic Processors/Memories/Interfaces 294 p. \$6.95
- Switching Regulators & Power Supplies 252 p. 128 il. \$6.95
- TV Schematics: How to Read Between the Lines 252 p. \$5.95
- Microelectronics 266 p. 228 il. \$5.95
- Electronic Music Circuit Guidebook 224 p., 180 il. \$6.95
- MOSFET Circuits Guidebook 196 p., 104 il. \$4.95
- Electronic Conversions, Symbols & Formulas 224 p. \$4.95
- Zenith Color TV Schematic/Svcgng Manual, Vol. 4 196 p. \$5.95
- CB Schematic Servicing Manuals, each 200 p. \$5.95
- Vol. 1 Kris Browning, Hy-gain J.C. Penney (Pinto) Vol. 2 Teaberry Unimetrics, Pearce-Simpson Silttronix Vol. 3 E F Johnson (Messenger), SBE-Linear, Sonar, Royce Vol. 4 Pace, Fanon/Courier, Dynascan (Cobra). \$8.95
- Aviation Electronics Handbook 406 p., 227 il. \$6.95
- Digital/Logic Electronics Handbook 308 p. 226 il. \$5.95
- CB Radio Operator's Guide 256 p. 139 il. \$6.95
- Central Htg. & Air-Condng. Repair Guide 320 p., 285 il. \$5.95
- RCA Color TV Schematic/Servicing Manual, Vol. 5 196 p. \$5.95
- Practical CB Radio Troubleshooting/Repair 210 p., 108 il. \$5.95
- Advanced Applic's for Pocket Calculators 304 p., 275 il. \$5.95
- Small-Screen TV Servicing Manual 240 p., 367 il. \$5.95
- Transistor Theory for Technicians & Engineers 224 p. \$5.95
- TV Troubleshooter's Handbook—3rd Ed. 448 p., 300 il. \$4.95
- Tower's International Transistor Selector 140 p. 7" x 10" \$4.95
- Color TV Case Histories Illustrated 238 p., 219 il. \$5.95
- The Home Appliance Clinic 195 p., 61 il. \$4.95
- The Complete FM 2-Way Radio Handbook 294 p., 111 il. \$6.95
- Effective T shooting With EVM & Scope 238 p., 185 il. \$5.95
- RF & Digital Test Equipment You Can Build 252 p., 217 il. \$5.95
- Basic Digital Electronics 210 p., 117 il. \$4.95
- Color TV Trouble Factbook—2nd Edition 348 p. \$4.95
- Servicing Cassette Cartridge Tape Players 294 p., 196 il. \$6.95
- Small Appliance Repair Guide—Vol. 2 210 p., 119 il. \$4.95
- Electronic Measurements Simplified 240 p., 217 il. \$4.95
- CET License Handbook 276 p., 244 il. \$5.95
- 10-Minute Test Techniques for PC Serv 216., 114 il. \$4.95
- Auto Stereo Service & Installation 252 p., 245 il. \$5.95
- Logical Color TV Troubleshooting 240 p., 151 il. \$5.95
- Cassette Tape Recorders—How They Work—Care/Repair. \$4.95
- Pictorial Guide to CB Radio Installation & Repair 256 p. \$5.95
- TV Bench Servicing Techniques 228 p., 177 il. \$4.95
- How To T shoot & Repair Electronic Test Equip. 252 p. \$6.95
- Modern Communications Switching Sys 276 p., 171 il. \$17.95
- Understanding & Using the VOM & EVM 192 p., 187 il. \$4.95
- Electrical Wiring/Lighting For Home/Office 204 p., 155 il. \$4.95
- Understanding & Using the Oscilloscope 272 p., 170 il. \$4.95
- FM Stereo/Quad Receiver Svcing Manual 192 p., 130 il. \$4.95
- MATV Systems Handbook 176 p., 91 il. \$4.95
- T shooting Solid-State Wave Generating/Shaping Circ. \$4.95
- 2nd Class FCC Encyclopedia 602 p., 445 il. \$7.95
- Pictorial Guide to Color TV Cir. Troubles 256 p., 262 il. \$4.95
- Manne Electronics Handbook 192 p., 106 il. \$4.95
- Installing TV & FM Antennas 168 p., 158 il. \$3.95
- Simplified TV Trouble Diagnosis 320 p., 292 il. \$5.95
- Pictorial Guide to Tape Recorder Repairs 256 p., 320 il. \$4.95
- Introduction to Medical Electronics 272 p., 126 il. \$6.95
- Troubleshooting Solid-State Amplifiers 256 p., 95 il. \$4.95
- How to Solve Solid-State Circuit Troubles 304 p., 161 il. \$5.95
- T shooting Solid-State Elec. Power Supplies 192 p. \$4.95
- How to Interpret TV Waveforms 256 p., 250 il. \$4.95
- Kwik-Fix TV Service Manual 384 p. \$5.95
- How to Repair Musical Instrument Amps 288 p., 250 il. \$5.95
- Solid-State Circuit T shooting Guide 224 p., 150 il. \$4.95
- Installing/Serv. Elec. Protective Systems 252 p., 160 il. \$4.95
- Using Elec. Testers for Auto Tuneup 252 p., 226 il. \$4.95
- All-in-One TV Alignment Handbook 304 p., 145 il. \$6.95
- 199 Color TV Troubles & Solutions 224 p., over 180 il. \$4.95
- 199 Electronic Test & Alignment Tech. 224 p., 130 il. \$4.95
- Digital Electronics: Principles & Practice 288 p., 191 il. \$5.95
- Industrial Electrs: Principles & Practice 416 p., 380 il. \$8.95
- Commercial FCC License Handbook 444 p., 150 il. \$5.95
- Citizens Band Radio Service Manual 192 p., 36 il. \$5.95
- How to Use Color TV Test Instruments 256 p., 230 il. \$4.95
- Modern Radar—Theory, Operation, & Maint. 480 p. \$7.95
- Popular Tube-Transistor Substitution Guide 256 p. \$3.95
- 199 TV Tough-Dog Problems Solved 252 p., 199 il. \$5.95
- Major Appliance Repair Guide 288 p., Illustrated. \$5.95
- Computer Technician's Handbook 480 p., over 400 il. \$8.95
- Vectorscopes-Oscilloscopes/Sweep-Marker Gen. 256 p. \$4.95
- Servicing Modern Hi-Fi Stereo Systems 248 p., 24 il. \$4.95
- Pulse & Switching Circuits 256 p., 184 il. \$5.95
- How to Repair Home/Auto Air-Conditioners 206 p. \$4.95
- Home-Call TV Repair Guide 144 p. \$3.95
- Small Appliance Repair Guide—Vol. 1 224 p., 100 il. \$4.95
- Installing/Serv. Home Audio Systems 256 p., 150 il. \$5.95

Money Generator

PAT. PEND.



ATC-10 COLOR BAR PATTERN GENERATOR

- Extra wide range RF/IF attenuator for testing receiver sensitivity.
- GRAY QUAD pattern for gray scale tracking checks/adjustments.
- COLOR BARS pattern with 6th bar marked to make your job easier.
- 3.58 MONITOR pattern for oscillator frequency checks with no need to short the AFPC test point.
- RED RASTER pattern for checking and adjusting purity at the flip of a switch.
- High level, 75 ohm output provided.
- 2 year factory warranty.
- 30 day money back guarantee.

Versatile

Next time you're repeatedly switching static and dynamic convergence patterns, think how much easier the composite HATCH-DOTS pattern below would make your job. It can also perform size, linearity, pincushion and centering checks. It's only one of several unique patterns produced by the ATC-10 that can save you time, trouble and most important - money. We'd love to show you how. Write us.

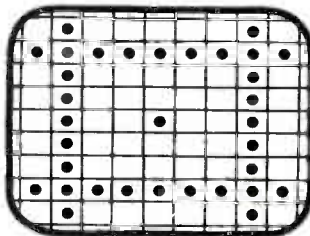

American Technology Corporation

225 Main Street, Dept. 5A, Canon City, Colorado 81212

NO RISK COUPON—MAIL ENTIRE AD

TAB BOOKS, P. O. Box 40 Blue Ridge Summit, Pa. 17214

Please send me the books checked above.

- I enclose \$_____ send postpaid
- Please invoice on 10-day FREE trial Send C. O. D.

Name _____ Phone _____

Company _____

Address _____

City _____ State _____ Zip _____

Foreign add 10% Pa. add 6% sales tax ES-56

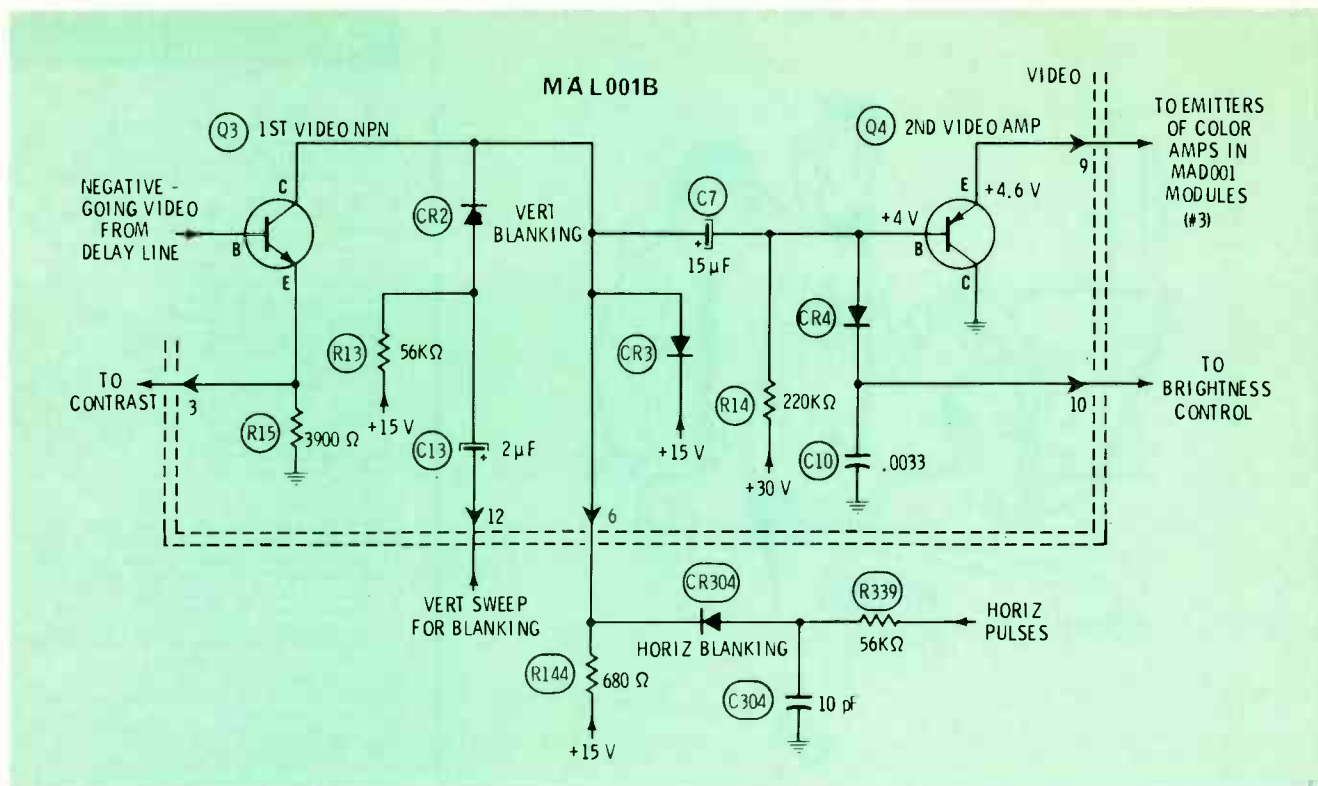

Fig. 3 Contrast is controlled by varying the bypassing of the Q3 emitter in MAL001B module. Positive-going blanking pulses from both the vertical sweep and the horizontal sweep are applied to the collector circuit of Q3. The direct coupling of all video stages is broken by C7, so CR4 functions as a DC restorer, making the raster brighter when the video is increased. Also, the brightness control changes the cathode voltage of CR4, varying the rectification which determines the bias of Q4. The emitter of Q4 drives the emitters of the three output transistors in the MAD modules.

(Continued from page 32)

through IC's is somewhat frustrating. In some cases, the signal can't be found except at the input and the output terminals. Even color saturation and tint variations are accomplished by controls that change DC voltages applied to IC's.

However, there are enough test-points for us to determine which module has a chroma defect. The important waveforms and locations are shown in Figure 6.

Circuits of the MAD001A modules seldom are explained. Perhaps that's because many of the modules are encapsulated in epoxy, and they can't be tested internally or repaired. But they are important to proper operation of video, chroma, and brightness of the picture tube.

Circuits of MAD001A Modules

Principal functions of the three MAD001A modules are to amplify the signals from the chroma demodulators, and to mix the chroma with a proper amount of b-w video. At each module's output, the pre-CRT-matrixed color and b-w signals are ready for application to

one cathode of the picture tube. None of the picture-tube control grids have any signal (except horizontal blanking).

MAD001A schematic

The complete schematic of a MAD001A module is shown in Figure 7. Q1 is the only amplifier; Q2 and circuit provide a stable bias for Q1.

A demodulated -Y signal (either R-Y, B-Y, or G-Y) comes in at terminal 2, and goes direct to the base of Q1. Both the AC chroma signal and the DC voltage are supplied by the demodulator module, MAE001B.

The video signal enters the module at two different terminals. One is terminal 3, where the amplitude is attenuated by a voltage divider consisting of R7 versus the combined resistances of R5 and the effective resistance of Q2. (R6 and C2 improve the high-frequency response.) Output of the divider goes to the emitter of Q1.

However, some means of adjusting the amplitude of video at the emitter is required for proper b-w

tracking of the picture tube. So, adjustable video is brought to terminal 4 (the emitter of Q1) through an external drive control and a 150-ohm resistor.

During gray-scale adjustments, all three drive controls are turned completely clockwise, the color control is turned down, then one or two of the drive controls are turned down enough to give good tracking of both highlights and lowlights in the b-w picture.

Mixing of the color and video signals occur inside Q1. Of course, the chroma signal is inverted, but the video is not. This must be considered, when you analyze the waveforms with a scope.

Stabilizing actions

Both AC and temperature stabilizations are supplied by Q2 and its associated components. Suppose the temperature of Q1 increased, for any reason. That would cause Q1 to draw more collector current, thus decreasing the collector voltage, and increasing the brightness (an undesirable condition). To cancel this brightness change, the bias of

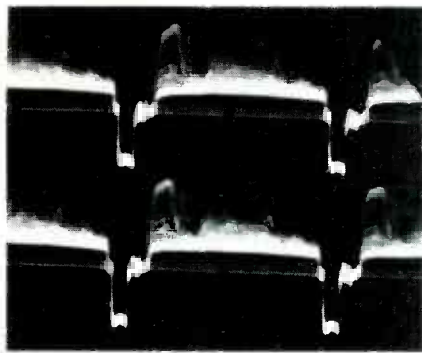

A

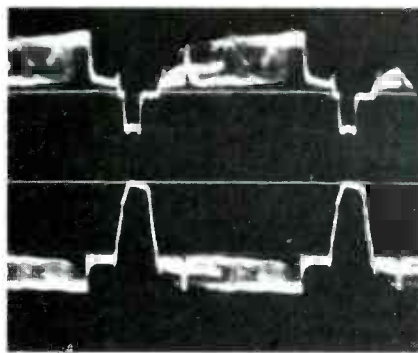

B

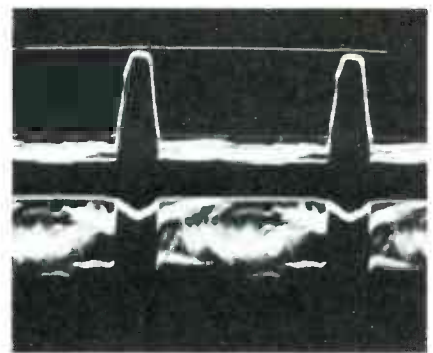

C

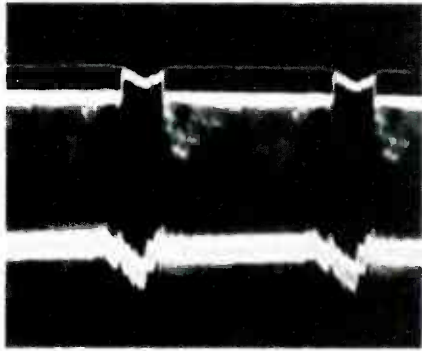

D

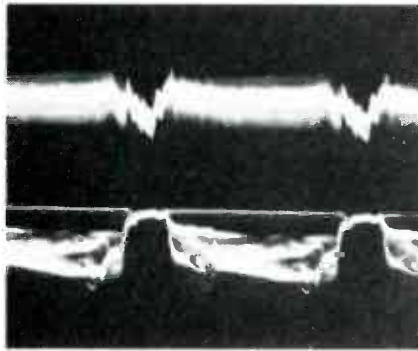

E

volt PP collector waveform after application of the blanking is shown by the bottom trace. (C) The base signal of Q4 comes from the collector of Q3, so they are almost identical (top trace). At Q4's emitter, most of the horizontal blanking has been cancelled by negative-going pulses through R329, leaving a video signal of about 1 volt PP. (D) The same video is fed to all three Video Drive controls (top trace); and below is shown the small 0.15 volt PP signal at the emitter of Q1 on a MAD001A module. Evidently, some chroma bleeds over from the base. (E) Q1 emitter video is shown above; the blanking in the video at the collector (bottom trace) varies in amplitude according to the brightness setting. Video amplitude between 80 and 120 volts PP has been measured.

Q2 changes; in turn increasing the emitter voltage of Q1, which raises the collector voltage.

In order to understand how the bias of Q2 changes, we must go back a couple of steps to the pulses at terminal 5.

Fig. 4 These are the video waveforms. (A) Signals at the base and emitter of Q2 on MAK001B both have the same waveform at 6 volts PP. (B) The top trace shows the 2-volt PP signal at the base of Q3 on MAL001B; and the 5-

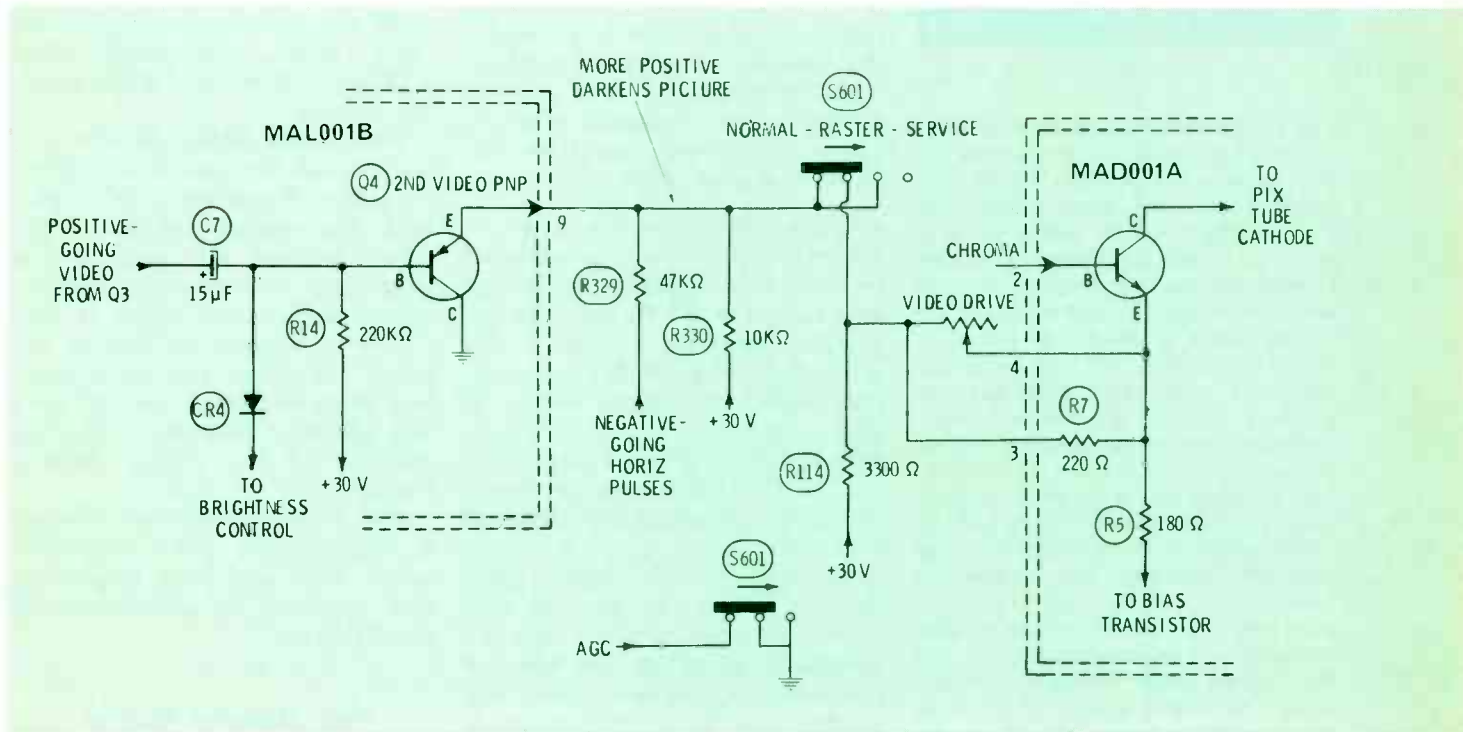
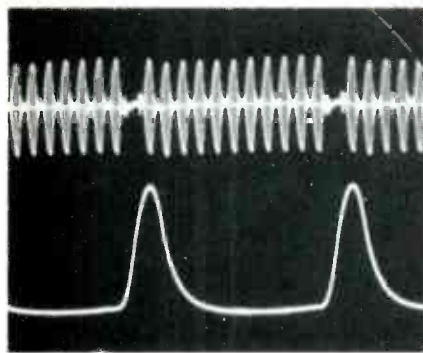
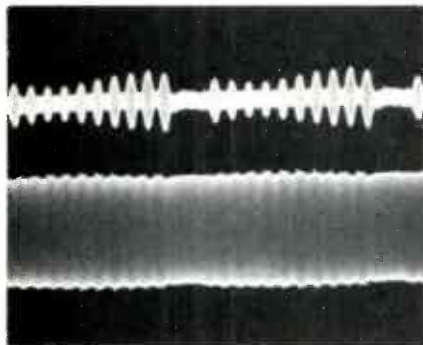

Fig. 5 This partial schematic shows some circuit details between the last video stage in MAL001B and the picture tube. In the "raster" position of the Normal/Raster/Service switch, the AGC is excessive (eliminating the video) but the brightness control operates. The "service" position applies a fixed bias to the Q1 transistors in the MAD modules, so the screen controls can be adjusted accurately while the vertical sweep is dead.



A



B

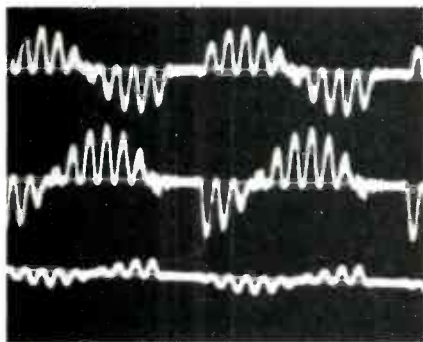

C

Fig. 6 Important chroma waveforms of color bars are shown in this series. (A) Top trace is the 0.4 volt PP chroma signal at terminal 3 (input) of MAC002B module. The 8 volt PP keying pulse at terminal 7 (bottom trace) is phased correctly for the first envelope of 3.58-MHz, which will be used for burst. (B) At terminal 4 of MAE001B (input) is found 0.12 volt PP of color-bar envelopes, now only 10 because of blanking. The 2.8 volt PP continuous 3.58-MHz carrier at terminal 10 is shown by the lower trace. (C) Following demodulation in the MAE module, these color-bar waveforms are sent on to the bases of Q1 transistors in the three MAD modules. Top waveform is found at the red Q1 base (about 1.1 volts PP); 1.2 volts PP of blue chroma is shown by the center waveform; and the bottom trace shows the small-amplitude chroma signal (0.4 V PP) at the base of the green Q1. Of course, Q1 inverts the chroma signal, so these waveforms will appear inverted at the collectors (cathodes of the picture tube).

Until you actually measure the voltages and look at all the waveforms, the purpose of the positive-going pulses at terminal 5 of the MAD modules appears to be for blanking of the picture tube. It would seem the pulses go through C3, CR2, CR1, and R2 to the CRT cathode.

However, the waveforms prove otherwise, because at the CRT cathode only a small amplitude of the pulses show. That means the pulses are not intended for blanking.

Without any pulses, the voltage at the junction of R8 and R9 (Figure 7) would be about +23 volts (2.2M versus 220K, starting with a B+ of 230 volts). Yet a meter shows around +3 volts there. **The 20-volt difference is caused by pulse rectification by the diodes.**

C3, CR2, and CR1 comprise a portion of a shunt-type peak-reading rectifier circuit that produces a negative voltage at the anode of CR2. Of course, this does not appear as a negative voltage because of the +23 volts which otherwise would be there. The two voltages nearly cancel.

Load of the rectifier is R2 and the C/E resistance of Q1. And the rectifier efficiency is changed by the positive voltage at the collector of Q1. Therefore, as the collector voltage goes up or down, it changes the amount of negative voltage that's rectified.

This is the sequence when a higher temperature increases the collector current of Q1:

- the collector voltage goes down;
- more negative voltage is produced by diode rectification of the pulses;
- the voltage at R8/R9 becomes less positive, decreasing the bias of Q2;
- collector voltage of Q2 increases, thus raising the emitter voltage of Q1;
- this is reduced forward bias of Q1, so the collector voltage rises, partially cancelling the original decrease.

But what of the pulses going through R9 to the base of Q2? Waveforms show virtually no pulse amplitude at either the base or collector. C1, between base and emitter, acts as negative feedback to eliminate all waveforms. The effect is the same as much-larger capacitances from base to ground, and collector to ground.

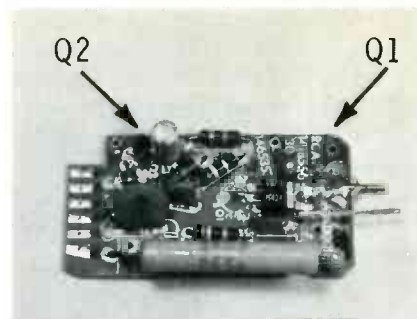

This is the appearance of MAD001A modules that have discrete components. Some MAD modules are encapsulated, and those cannot be repaired.

Why DC And Pulses?

A minor mystery was revealed by the schematic of Figure 8, which shows the source of the pulses at terminal 5 of the MAD modules. R340, R341, and R331 form a voltage divider that applies a DC voltage (+71 volts, calculated) to the pulses at the output of C309.

And yet, a DC meter measured +35 volts at the junction of R341 and R331. How can this be correct?

The DC waveform in Figure 8 gives the answer. Without the DC brought in by the voltage divider, the zero-voltage line would be above the line between pulses, as shown, and the waveform would read zero DC volts. Positive-peak amplitude (above the zero line) would not be enough to make the CR307 anode more positive than +230 volts; therefore, CR307 would not conduct.

With the DC added, the zero line is even with the base line between the pulses. Therefore, a DC meter reads the **average** voltage of the pulses, because **all** parts of the pulses are now positive! Another way to analyze the action is that CR307 is clipping the tips of the pulses. Of course, this is rectification which produces about -35 volts that subtracts from the +70 volts supplied by the voltage divider, leaving about +35 volts.

Why is CR307 included? Without its clipping the pulse amplitude would vary with the brightness, thus upsetting the stabilization of the Q2 circuit.

Four Modules Ruined By One Short

Although the facts are embarrassing to me, I'll tell them, because they illustrate the damage

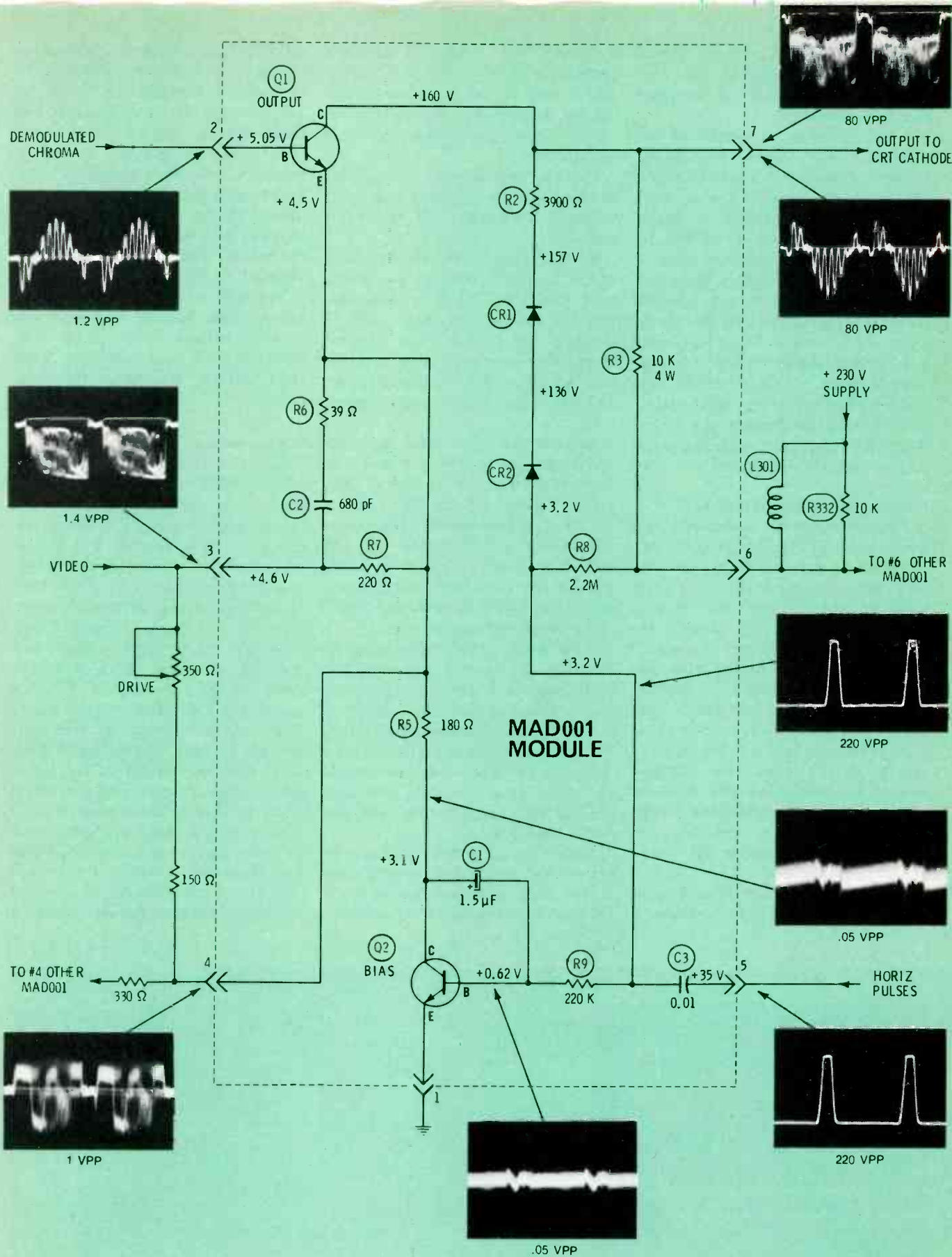

Fig. 7 Here's the complete schematic of a MAD001A module which matrixes the video and chroma signals, and applies the amplified signals to one cathode of the picture tube. Waveforms and DC voltages also are included. Two waveforms are shown at the output, one for color bars, and the other having a station signal.

that's possible from a minor slip of a test probe. (Those of you who have never had such an accident can feel superior.)

I was trying to be careful of accidental short circuits, even using prods with insulated hooks to make all the connections. All went well until I was connecting a scope probe at the anode of CR307, to photograph the waveform. But I didn't see another copper strip just under the diode. Yes, you guessed it! As I tried to remove the scope probe, the hook bridged the tiny gap between the diode lead and the copper wire. "Click" went the breaker; and the screen went black. After I reset the breaker, the raster was a full-brightness magenta, with retrace lines, but no video.

Testing without MAD001 modules

Those symptoms indicated defective red and blue MAD modules, and the two cathodes of the picture tube each tested only about +3 volts. I made a fast test of the transistors, finding Q2 shorted in one, and Q1 shorted in the other.

Now, no damage results from removing the CRT-cathode connector from a MAD module (that one color just disappears from the screen, unless the CRT has a H/C short). What's more, **no damage occurs by operating the chassis without any one or all of the MAD modules.** Of course, removing the green module eliminates all green from the raster, etc.

These facts give several safe tests when a defective MAD module is

suspected. For example, if there's a problem with just one color, cross-switch two of the modules. If the trouble moves with the module to another color, the defective module is identified.

Or, you can operate without all three and test for chroma and +DC voltages at socket #2 for each module.

In this case, none of the three MAD modules provided a picture, so I concluded all were defective. Just to be on the safe side, I checked the DC at each chroma input. Two were near zero, and one was about right. Evidently, the MAE001 module had been zapped, also.

After a trip to the RCA distributor, I plugged in all four modules, but there was no raster of any color. I measured the DC voltages of all Q1 transistors. The bases were about +3, emitters +2.5, and collectors about +200 volts. This proved the transistors were nearly cutoff, and they in turn had cutoff the guns of the picture tube.

After some concentrated troubleshooting, and tracing the sources of both base and emitter signals, I finally found a short to ground at terminal 9 of module MAL001B. Normally, a video signal with about +5 volts DC from this point feeds the video drive controls, and ultimately the Q1 emitters on the MAD modules.

Reducing an emitter voltage increases the forward bias, saturating a transistor, and not cutting it off (as was the case here). Apparently,

the short also affected other supply voltages; a possibility I forgot to test, until it was too late.

I removed the MAL module and found that Q4 (see Figure 3) had a C/E short. Rummaging around in my stock, I found a couple of wide-bandwidth NPN transistors, soldered one in place, replaced the module, and confidently turned on the power. The picture tube finally warmed up, but no raster appeared.

Voltages of all Q1's were different than before. The approximate readings were: bases +6; emitters +5.5; and collectors +200 volts. All Q1 transistors remained cutoff!

The big detour

Did you catch the mistake I made? Well, I compounded the problem by following a false trail. For no logical reason, I turned up the CRT Bias control and found many horizontal lines, in red, blue, and green (see Figure 9). Were they caused by a wrong horizontal sweep frequency, or excessive height? The right end of the lines ended and reversed direction at a different point for the three colors. When I turned the CRT Bias up even more, some of the questions were answered. In back of the bright lines were dimmer normal raster lines! And a color picture (without video) could be seen in the background.

Perhaps the lines were some kind of audio oscillation (after all, I just had replaced a video transistor). But the scope showed no strange video waveforms. At one time, I

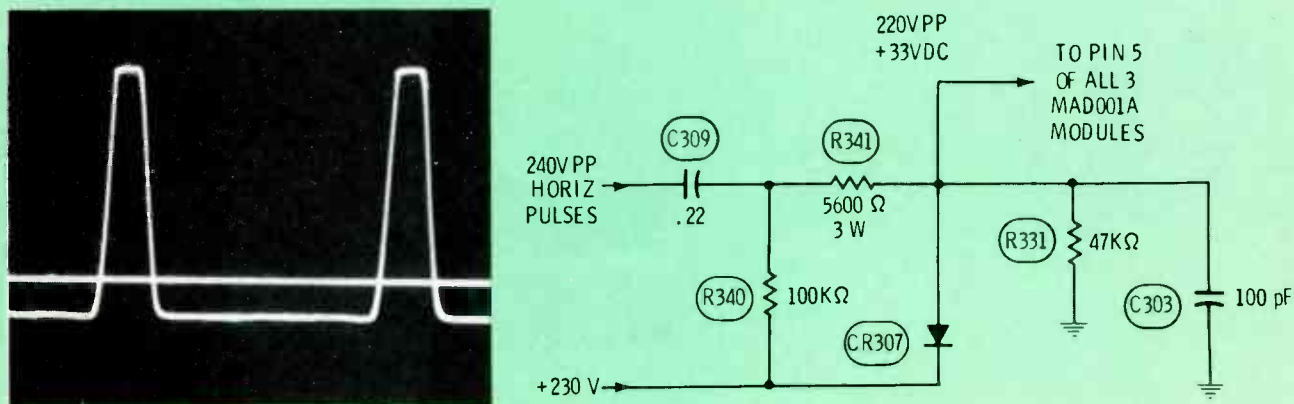

Fig. 8 Adding a positive voltage to the horizontal pulses raises them enough to allow the tips to be clipped by CR307. This produces a pulses that do not vary in amplitude. They are necessary for proper operation of the bias-stabilization circuit in MAD modules. The line across the waveform represents zero voltage without any DC added, and average DC voltage when DC is added to the pulses.

counted 20 groups of slightly-diagonal lines, which would have indicated pulses of about 1200 Hz repetition rate. Notice how scientific I was? Are you amused by the sight of a smart CET fumbling in the wrong direction? I can assure you, it was painful for me.

Finally, I thought of vertical-retrace lines. These were slanted the right direction. But there were too many lines. Or were there? Solid-state circuits usually have slower retrace times than with tubes. I gently rocked the vertical-hold control, but keeping it in lock. The diagonal lines moved rapidly up or down the screen. That proved the lines were retrace paths not blanked out by either video or blanking signals.

Again, suspicion swung to the MAL Q4 circuit. The collector was grounded, so it was zero, the emitter was about +6 (a bit high, but better than the former zero), and the base was -3 volts. What, -3 volts? But this base should be positive!

Thinking perhaps another component had been damaged at the same time the original transistor was ruined, I removed the transistor and tested other components. All were okay. Then, with the transistor still removed, I measured the voltage at the anode of CR4, with power on. The digital meter measured +0.637 volts, and the scope showed video with huge blanking pulses.

In desperation, I installed another NPN transistor, whose bandwidth was rated even wider than the other replacement. The results were the same: chroma, and retrace lines, but no video. And the base voltage of Q4 again measured about -3 volts.

I'll spare you any descriptions of my agony during the next hour, as I tried to use all my theory, logic, and the results of many tests with scope and digital meter.

The only way the base of Q4 could measure a negative voltage (I reasoned), would be if a diode (or equivalent transistor junction) were connected with anode to base and cathode to ground. And that's just where the emitter/junction of Q4 was located. However, a NPN transistor would be the equivalent of cathode of base and anode to ground. That's backwards.

Then, I noticed for the first time that Q4 was PNP polarity! I suppose the emitter drawn at the top confused me. The weird voltages now made sense. Without a Q4 transistor, CR4 was rectifying the video, producing a small negative voltage (less than in another circuit, because the cathode of CR4 had a positive voltage) which almost cancelled the positive voltage entering through R14, leaving about +0.6 volt. However, the wrong-polarity transistor produced more negative voltage (the "cathode" was grounded), and the DC voltage was about -3 volts.

It was almost an anti-climax to see a normal picture appear, after I obtained and installed the correct PNP replacement for Q4.

Lessons the hard way

Several important lessons can be learned from this time-wasting experience.

First, never allow intermittent opens or shorts when you touch the probes of test equipment to the circuits. If the wiring or the component leads permit, connect to the point being tested using the insulated-hook type of test probe **while the power is turned off**, and do not disconnect the probe, after the test, until the power is off again. If you can't keep a tight connection on the circuit side of a board, solder a small right-angle piece of bus wire to the copper wiring. Then connect the insulated-hook test probes to them for tests.

Use techniques and tools that enable you to remove and re-install soldered components without damage to either board or component. The Q4 connections, pictured in Figure 10, were soldered or resoldered about 11 or 12 times, yet the copper wiring remained in excellent shape.

Finally, when the results of the tests make no sense, examine all the things you have done, and look for mistakes. It's not unusual for a person to keep repeating a mistake. Then, when you're sure there are no mistakes, keep on doing tests until you get a "break". Something will give you a good clue, if you don't quit.

Comments

This concludes the series about the RCA CTC58 chassis, although we will present additional troubleshooting information later. □

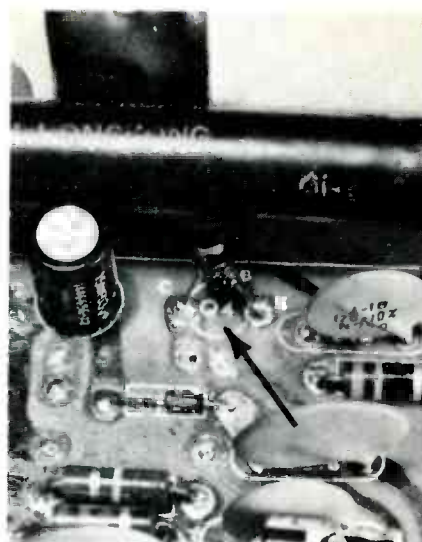

A black arrow points to Q4 on the MAL001B module. The black object above it is the delay line, which makes a fine video test point.

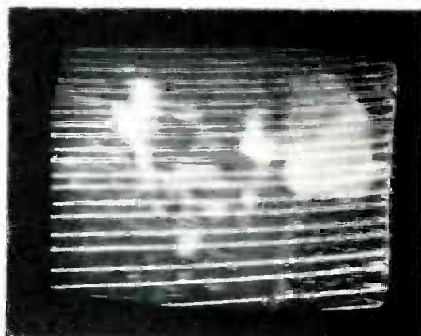

Fig. 9 When Q4 video stage was dead, these bright lines in red, blue, and green appeared. They were vertical-retrace lines, and very difficult to analyze. Recognition was helped by turning up the CRT Bias to provide a dim raster; and increasing the color saturation to show a picture without video, which proved both vertical and horizontal frequencies were okay.

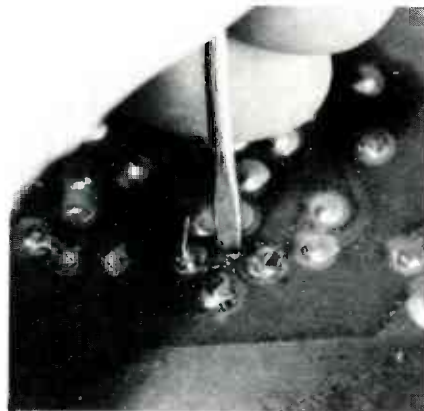

Fig. 10 Six transistors were removed and installed (in the three holes around the end of the screwdriver blade) without any damage to the board or lifting the copper.

How to select and install CB mobile antennas

Proper selection and installation is as important for a mobile antenna as it is for a base-station antenna. Antenna efficiency is generally of prime importance; however, physical appearance may also have some bearing on the selection of a mobile antenna and the type of installation.

By David E. Hicks

Antenna Placement

Another important consideration is the mounting location of the antenna on the vehicle. The quarter-wave whip uses the metal surface of the vehicle as the ground plane, but different locations present different ground-plane effects, which in turn produce variations in the antenna radiation patterns. Fig. 6-1 shows several mounting locations for mobile antennas. The three in Fig. 6-1 are the most common. Using them as examples, let us see what effect the mounting location has on the radiation pattern. Figs. 6-2, 6-3, and 6-4 show the radiation pattern obtained when a quarter-wave mobile whip is mounted on the roof, rear deck, and bumper, respectively. From these patterns it becomes obvious that the most desirable place to mount the whip is on the roof of the vehicle. However, this is not always possible. For example, a full-length (108-inch)

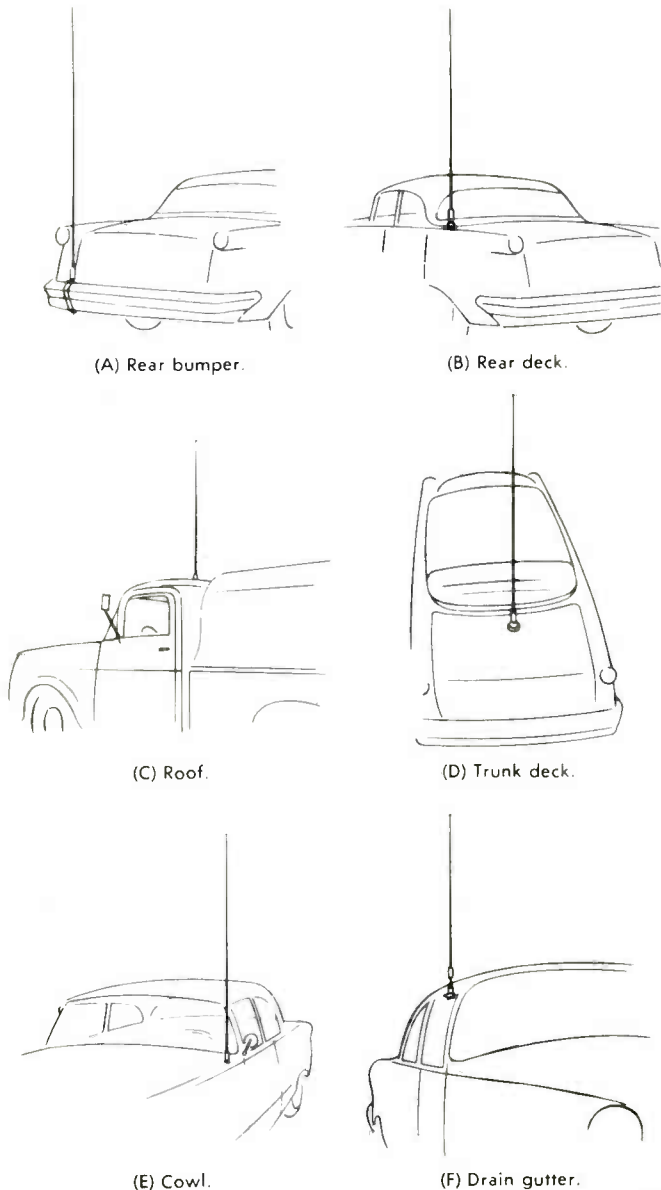

Courtesy Hy-Gain Electronics Corp.

Fig. 6-1 Typical mobile-antenna mounting locations.

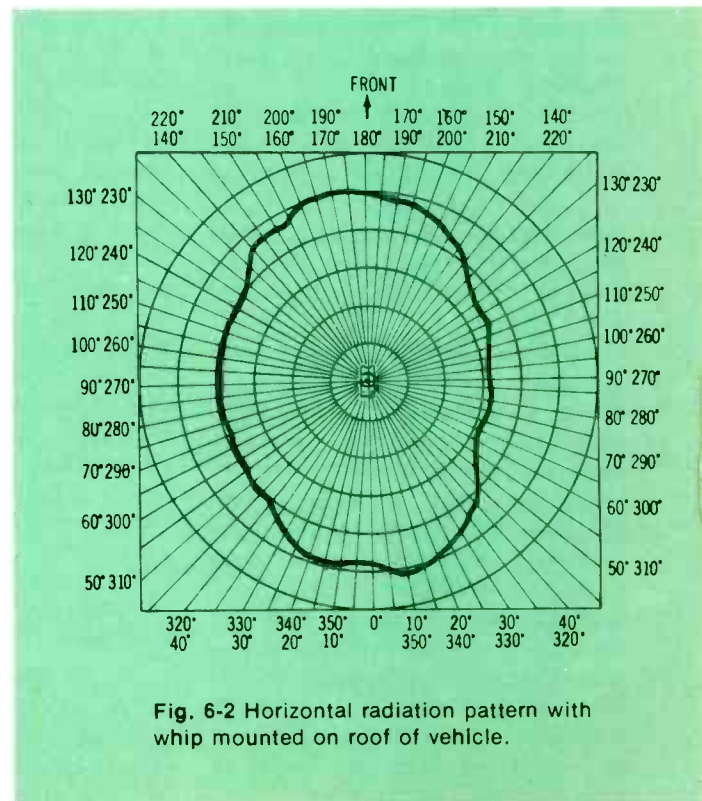

This article is reprinted by permission of Howard W. Sams & Company, from "CB Radio Antennas", book number 21100.

whip would be impractical mounted on top of a car or truck. One of the shorter, loaded whips would be more suitable here, but such a change might mean some sacrifice in efficiency. Therefore, the mounting location of the mobile antenna is often a compromise.

Mobile Antenna Types

Practically all mobile antennas are of the whip design. Some are a full quarter-wavelength long, while others employ loading coils to permit a reduction in their physical size. Most are constructed of either stainless steel or fiber glass and are available with mountings for permanent or temporary installations.

Problems often associated with mobile antenna installations are minimized by the wide variety of antenna sizes and mounting configurations available. For example, there are mobile antennas equipped

with suction-cup magnetic mountings which can be attached to any smooth surface on the vehicle and clamp-on mountings which fasten to the rain gutter of the car or truck, or to a luggage rack, the bumper, or the trunk-lid groove. None of these mountings require drilling holes in the vehicle. There are also special antenna mountings for campers, boats, and other vehicles.

Fig. 6-5 shows a typical center-loaded mobile whip with a mounting that permits the unit to be secured to the trunk-lid groove of a car. In contrast, Fig. 6-6 shows a center-loaded, full quarter-wave length whip attached to a bumper mount. This whip is constructed of fiber glass (with an embedded conductor) and can be used as a direct replacement for the 108-inch stainless-steel whip. The full quarter-wavelength steel mobile whips usually require a relatively

heavy-duty mounting equipped with a spring to absorb the mechanical shocks encountered during vehicular movement. Figs. 6-7 and 6-8 show two types of spring mountings for this purpose. The mounting in Fig. 6-7 swivels and can therefore be mounted on a flat, angular, or vertical surface while maintaining the whip in an upright position. The chain-type mounting in Fig. 6-8 clamps to the bumper and supports the whip in a vertical position. The latter mounting does not require drilling for installation.

Installation Methods

The remainder of this chapter covers three of the most popular mobile antenna installations—bumper, rear deck, and roof. Actual installation methods may vary according to the type and manufacturer of the antenna, the peculiarities of the vehicle, and the tools available. For this reason, the

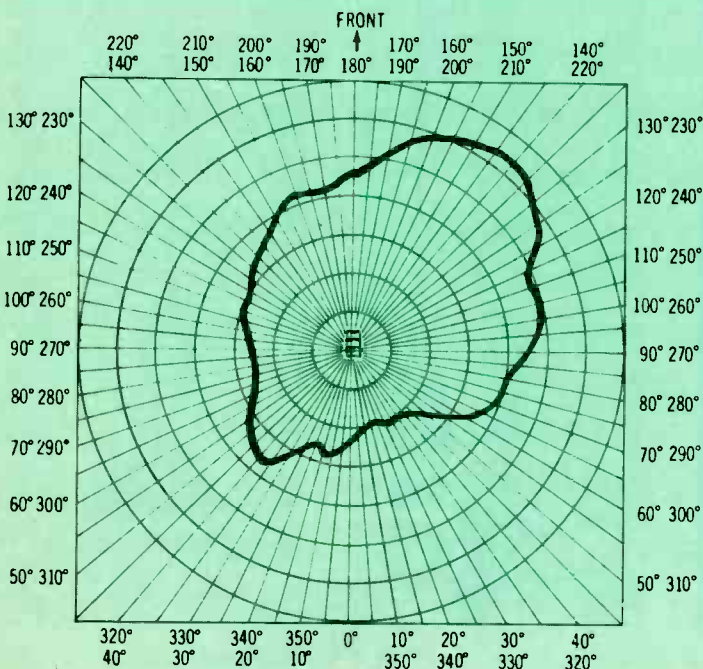

Fig. 6-3 Horizontal radiation pattern with whip mounted on rear deck (left side) of vehicle.

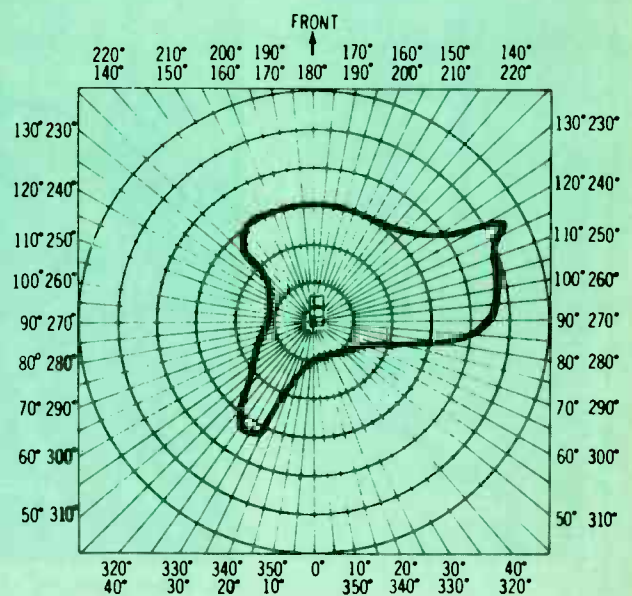

Fig. 6-4 Horizontal radiation pattern with whip mounted on rear bumper (left side) of vehicle.

procedures discussed are to be considered typical. Specific step-by-step installation instructions are normally provided with the antenna at the time of purchase.

The bumper mount

The bumper-mounted mobile antenna is undoubtedly the easiest to install, which probably accounts for much of its popularity. One of the most popular bumper mountings is the chain type which clamps directly over the edges of the bumper, as shown in Fig. 6-8. No hole drilling is required for this type of mounting, and it can be easily adjusted, with the steel mounting links in the center, to fit practically any American or foreign car. In Fig. 6-9 you can see how the coaxial transmission line is connected to the mounting. The outer vinyl jacket is removed from that portion of the cable that passes beneath the

grounding clip. A suitable terminal lug is soldered to the center conductor, which is fastened to the base as shown. The whip is then connected to the base, and the cable is routed to the radio equipment. It is better to bring this cable in through the trunk (even though a hole may have to be drilled) and run it beneath the floor mat to the radio equipment than to route it underneath the car, where it is exposed to any number of hazards.

Rear-deck and trunk-lid installations

Unless one of the clamp-on types of antenna mounts is used, it will be necessary to drill at least one hole in or near the trunk lid. If a base-loaded antenna with a snap-in mounting is to be installed, only one small hole is needed (the exact size will depend on the antenna model), and the installation is relatively simple.

With the spring-mounted swivel base, however, several holes must be drilled in the car body and the installation is somewhat more involved. To install such a mounting on the rear deck of a car, place one hand over the proposed location of the hole. With your other hand, reach inside the trunk (or under the fender with some cars) directly beneath this spot and feel around for any obstruction which might prevent the grounding plate from fitting flush against the car body.

After the exact mounting location has been determined, mark the holes, using the grounding plate as a template. Next, use a center punch to start the hole, as shown in Fig. 6-10. A shear punch makes a clean-cut hole. If a shear punch is not available, drill a hole large enough to accommodate a reamer. Be careful that the reamer does not slip out of the hole and mar an

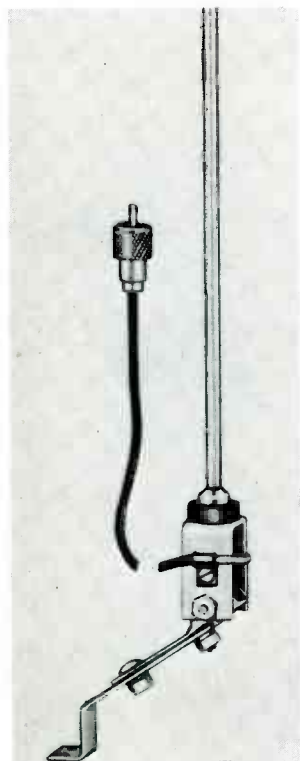

Fig. 6-5 Typical center-loaded mobile whip equipped with trunk-groove mounting.



Fig. 6-6 A center-loaded quarter-wave whip constructed of fiber glass and mounted on the bumper.

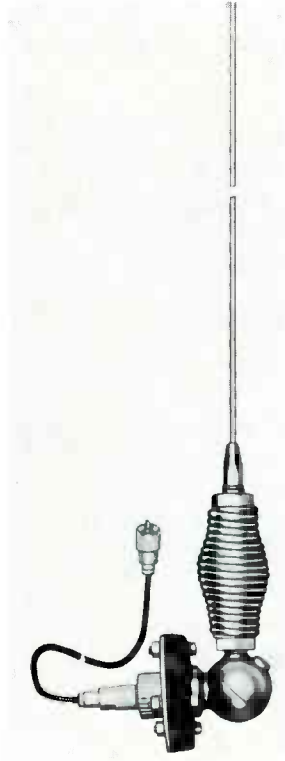

Fig. 6-7 A typical spring-mounted quarter-wave mobile whip.



Fig. 6-8 A popular chain-type bumper mount that can be installed without drilling any holes.

otherwise good paint job.

After all mounting holes have been drilled, assemble the swivel joint and spring mounting, as shown in Fig. 6-11, and mount the assembly in the space provided. Then adjust the swivel joint (Fig. 6-12) until the whip is correctly positioned. Route the transmission line from the transceiver, under the floor mat and rear seat, into the trunk compartment. Then connect the coaxial cable to the base of the whip mounting as shown in Fig. 6-13. Here again, be sure all connections are tight. Notice that a small ferrule is slipped underneath the shielding braid where the cable passes under the grounding clamp. It provides a good contact with the braid and also prevents the cable from being crushed when the grounding clamp is tightened.

Roof installation

In this discussion we will show how to install the mobile whip in Fig. 6-14. This antenna is designed for the 130- to 470-MHz bands and may therefore be cut for operation at the class-A CB frequencies. It may be mounted on any flat surface, such as the roof, cowl, fender, or rear deck. Here, however, only the roof-top method will be discussed. Mounting the antenna is quite simple. Only a single hole need be drilled, and it is usually unnecessary to remove any upholstery. This same mounting arrangement is used for many of the base-loaded class-D mobile antennas described previously.

The first step is to decide exactly where the antenna should be mounted on the roof. As before, feel around to make sure there are no obstructions, particularly wires leading to the dome light. Now mark, center-punch, and drill the proper size hole in the roof (Fig. 6-15A). Feed the coaxial cable through the hole (Fig. 6-15B) and run it between the headliner and the roof to a point where it can be brought out for connection to the radio equipment. This may require the use of a fish tape, or in some instances it may be more practical to drop the headliner. Leave ap-

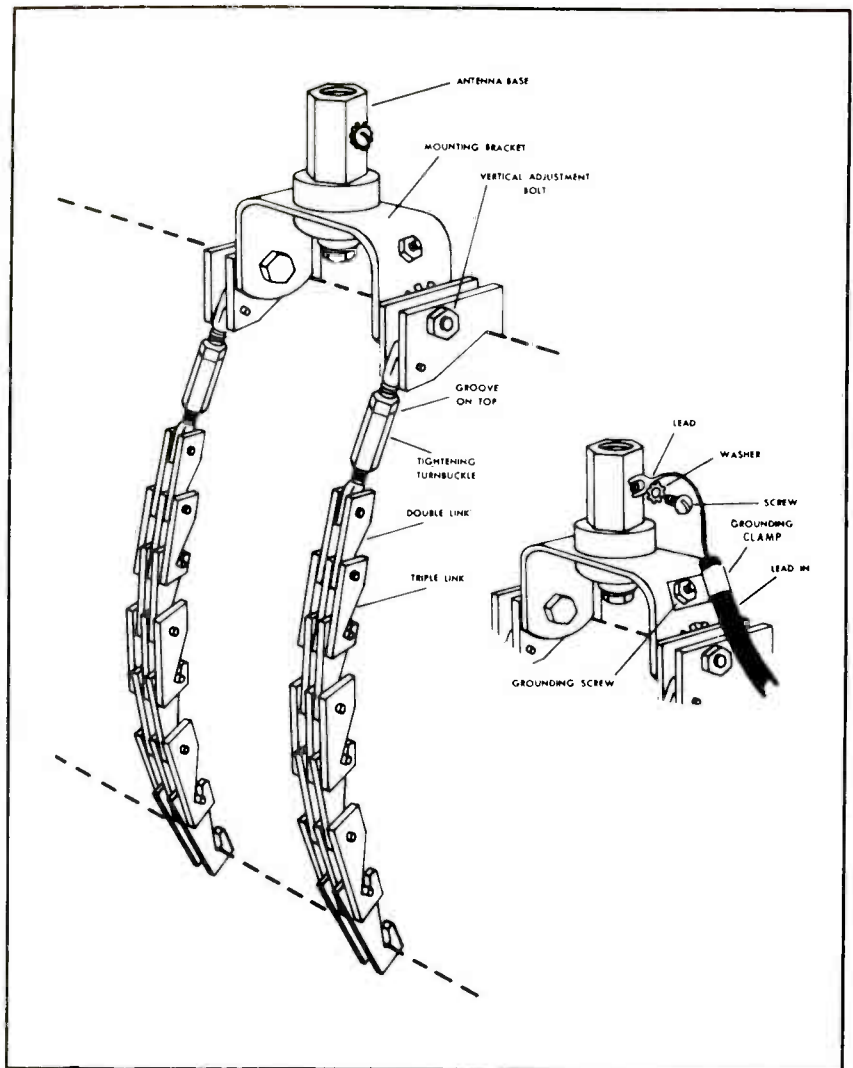

Fig. 6-9 Installation details for the Model M-191 bumper-mount assembly.

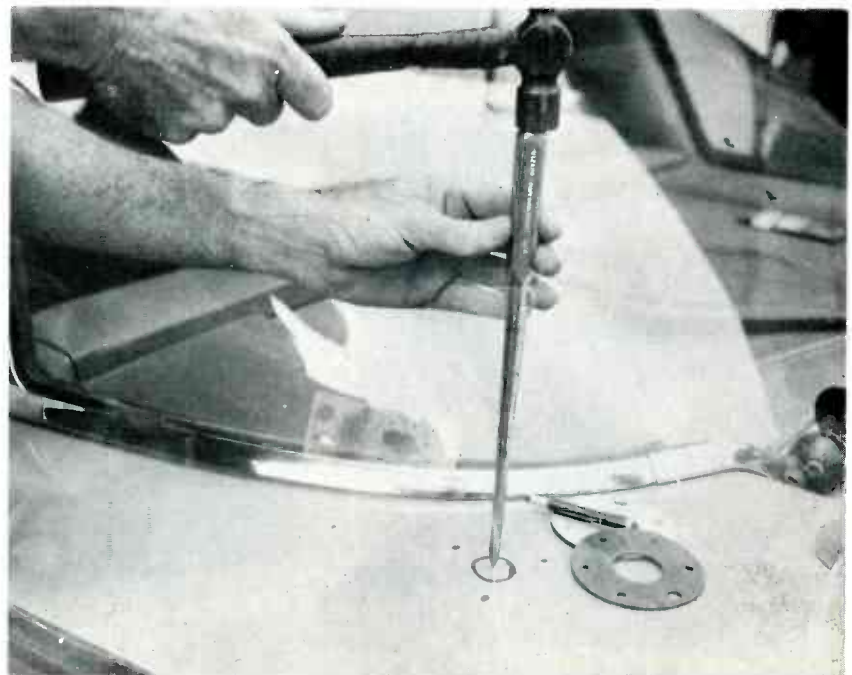

Fig. 6-10 Using a punch to start the center hole.

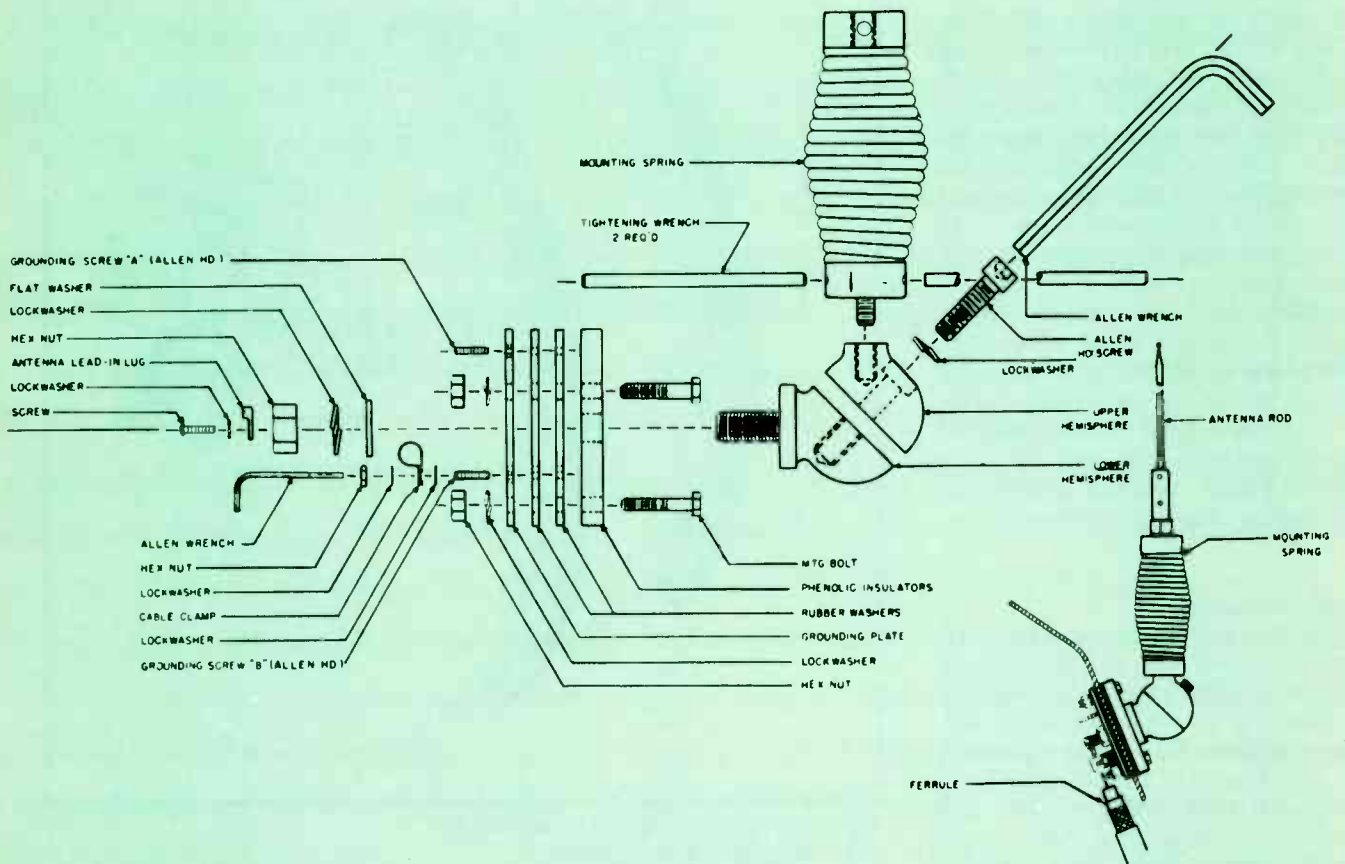

Fig. 6-11 Exploded view of base assembly showing relationship between the various components.



Fig. 6-12 Method of positioning the mobile whip.

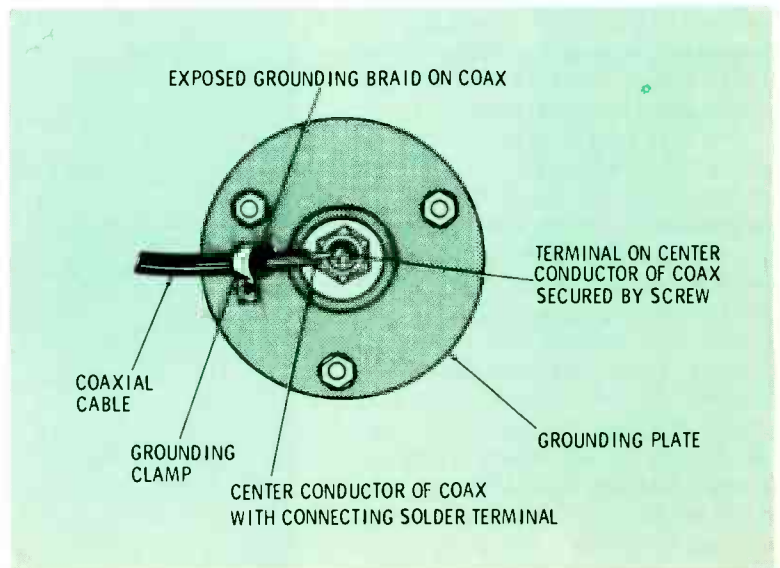

Fig. 6-13 Method of connecting coaxial cable to swivel base.

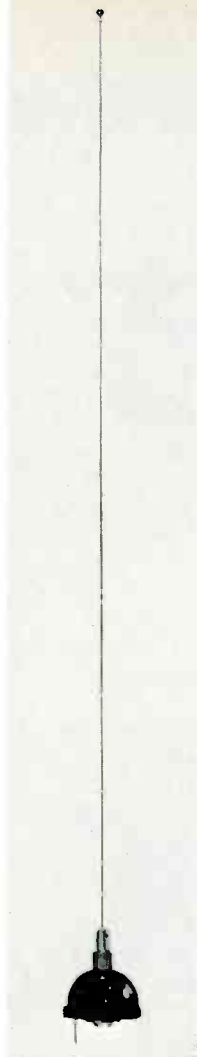

Fig. 6-14 A quarter-wave UHF mobile whip for Class-A CB operation.

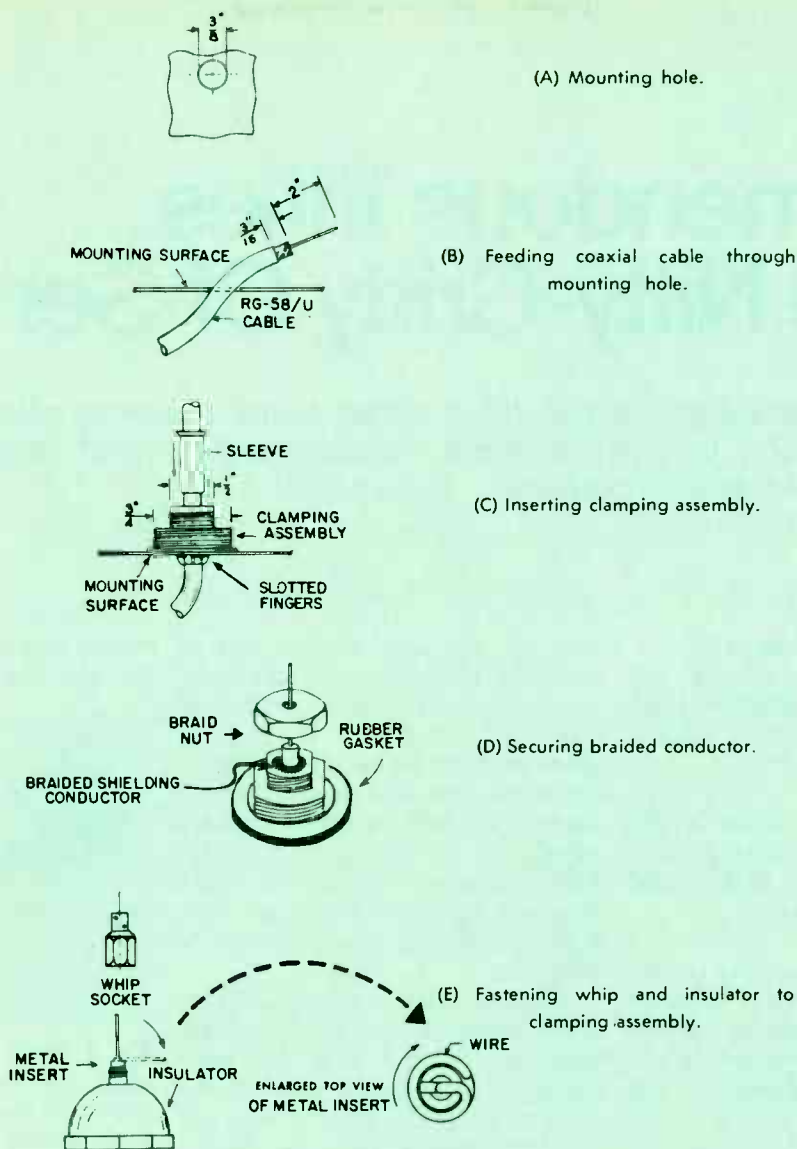

Fig. 6-15 Method of installing the mobile whip of Figure 6-14, on the roof of a vehicle.

proximately 4 feet of cable exposed and dress the end of it as shown.

Insert the clamping assembly over the exposed end of the cable, as shown in (Fig. 6-15C), and press the slotted fingers (at the base of the clamping assembly) into the hole. Insert the sleeve into the assembly until the flared end is flush with the top. Hold the clamping assembly securely by the 1/2-inch flats and tighten the threaded nut on the 3/4-inch flats until the entire assembly is secured to the mounting surface. Next, fan out the shielding braid, as shown in Fig. 6-15D, and push the cable into the clamping assembly until the braid wires lay flat on top of the assembly.

The inner conductor of the cable

should now be extended upward through the braid nut. Then tighten the nut until the braid is securely clamped. Next place the rubber gasket over the clamping assembly and flat against the mounting surface. Extend the inner conductor straight upward through the insulator and metal insert (Fig. 6-15E), and thread the insulator onto the clamping assembly. Pull the wire through the slot of the metal insert and wrap it clockwise around the shoulder of the insert. Any excess wire can now be cut off.

If the whip is not cut to the correct length, it can be removed from its socket by loosening the two small screws. The final step is to thread the whip socket onto the metal insert until the wire is

clamped securely against the shoulder.

This completes the roof-antenna installation except for cutting the opposite end of the coaxial cable to the correct length and fastening the proper connector to it. This should be done in the same manner as described previously in Chapter 5.

The exact procedure for mounting any roof antenna may vary not only from one type of antenna to another but also with different manufacturers of the same type of antenna. The procedure described here is intended only as an example of what is normally involved in an installation of this type. In all cases, follow the procedure outlined by the manufacturer for the specific antenna involved. □

Tremendous Trifles... The Nitty-Gritty Of Servicing

Here are practical suggestions about some subjects often ignored: making solid test connections; desoldering without damage; and how to solder correctly. By Carl Babcoke

Physical Problems

- How can you check the DC voltage at a certain resistor, when the resistor is on a module plugged in between two others?
- Have you ever had a test probe slip, while you were checking a live chassis, causing a short that "wiped out" several transistors?
- What about the time your soldering iron tip was so hot it loosened the copper foil from a circuit board, thus changing a simple transistor replacement into an extensive board repair?

These are typical every-day nitty-gritty problems concerning the physical side of servicing solid-state radios, stereos, and television receivers. Sometimes, such problems give a technician more work and worry than the electronic trouble-shooting.

The solution of these headaches is to prevent them before they occur. No large amount of money is needed (although you probably should buy a new type of soldering iron, and some inexpensive test probes). The main thing you need is information, which we will try to supply.

Delicate Components

First, you must appreciate the nature of the components we work with. Although these machines as a whole unit are rugged, the individual components and circuit boards must be treated with care.

Solid-state devices can develop internal opens or intermittents, but

they do not weaken with age as tubes do. However, tubes can withstand overloads for a period of time, but solid-state components short out from an overload before a protective fuse can blow. Once, I zapped an audio-output transistor merely by connecting a .1 microfarad capacitor across an input coupling capacitor! Such an overload would not have affected a tube.

This inability of solid-state components to withstand certain overloads requires that the technicians *always* connect *solidly* to the correct test point, and without any accidental shorts. Most test probes now are obsolete, and should not be used on circuit boards, or other high-density wiring.

Circuit boards are not as sturdy as they appear to be. They can crack from physical strain. The solder of any joints carrying a large current can deteriorate, becoming rough. Around some rivets, a tiny black circle is the only visible evidence of an open circuit.

The copper wiring strips are strong enough for the normal currents and mechanical strains. But they apparently are stuck to the boards by some kind of adhesive, and excessive heat melts the bonding, allowing the copper strips to rise. Away from the board, the copper is weak and subject to damage. Any loose copper wires should be properly repaired, because they could cause opens or shorts later.

Well, these are some of the mechanical problems with electronic equipment using circuit

boards and modules. The following tips give some of the answers.

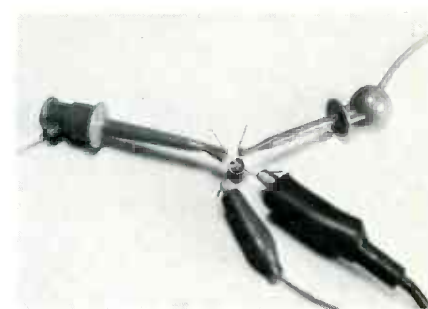

Tip 1 With transistor leads wide apart, as shown, any of the four clips can make solid contact, with little chance of a short. But most transistors are mounted near a board, leaving insufficient clearance for alligator clips (at the bottom). The Pomona Grabber (upper left) and the EZ Hook (upper right) are thin enough to slide under the transistor. Kleps Hookon and some new scope probes also operate this way.

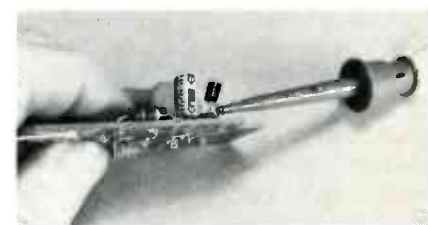

Tip 2 These test probes with hooks have internal springs that pull the hooks back inside the insulation, so only the tiny part that encircles the lead is exposed. After the hook is attached, there is almost zero chance of any short circuit. That's not true while the hook is being attached or removed; therefore, turn off the power at those times.

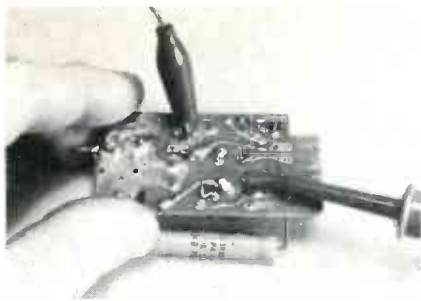

Tip 3 If you need to make a test connection to the wiring side of a board or module, solder a small right-angle piece of tinned wire to the required pad. Any kind of clip can be used then, if space permits. But the hook type has less danger of shorts. Unless the circuit is very-sensitive to capacitance (such as the IF's), the bits of wire can be left in place. These added wires save time by minimizing shorts and blown transistors.



Tip 4 IC's are hard to attach to, even with hook-type probes. Where added capacitance is not a problem, the best answer is to use a clip made like a clothes-pin to snap over all IC leads at once. The Pomona Dip-Clip is shown connected to an out-of-circuit IC, with a test connection made by a Grabber to a connector extending from the top.

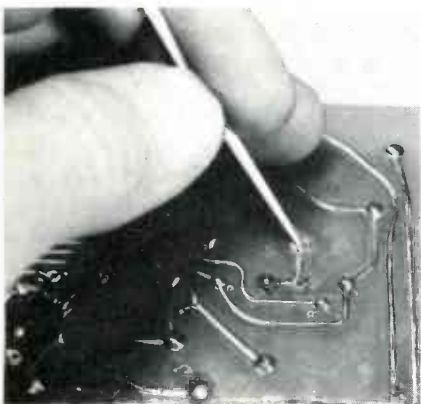

Tip 5 Removing solder to permit extraction of a component lead was often a frustrating chore before some of the new tools were developed. For example, a plain, round, wooden toothpick can be

used to punch out the hot solder before it solidifies. This works best after most of the solder has been picked up by the iron tip.

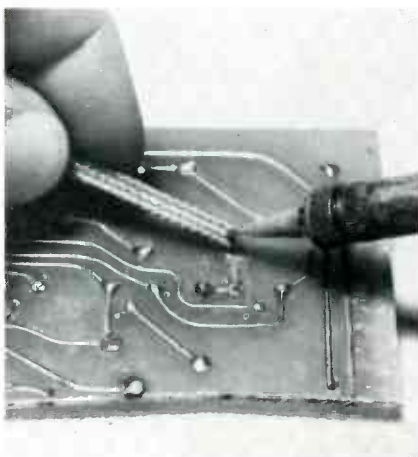

Tip 6 Wire braid can be used as a wick to sop up excess solder. Some care is necessary, else the braid might stick to the copper wire and cause damage when it is lifted. Some manufacturers offer braid of several sizes, with flux built-in, and with a channel to brace the braid. Braid does not extract solder from holes as well as the vacuum devices (to be described next), but it can be used in smaller spaces.



Tip 7 Vacuum desoldering tools are becoming deservedly popular now. Most are armed by pressure on a lever; then, when the chamber is minimum size, a catch or trigger

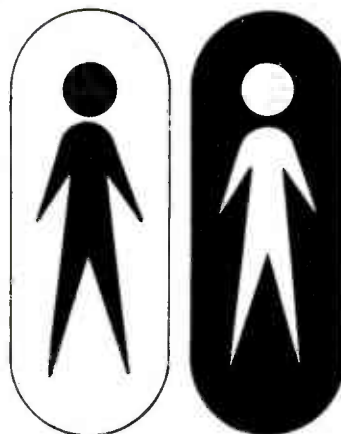

LIFE OR DEATH SITUATION

Not all 2-way radios warn about Smokies taking pictures.

Professional FM two-way radios—the most important ones—are for bringing help fast in life or death emergencies. And if you've had some serious electronics experience you just might fit into this important, expanding field.

MTI is the only home study school that deals exclusively with service and repair of professional two-way radios.

Think you're good enough to become part of it all? Drop us a line to find out.

Please send me more information.

Name _____

Address _____

Code _____

- I am a former MTI student.
 I am presently in the military.
 I am a veteran. 58

MTI

Formerly

MOTOROLA TRAINING INSTITUTE

College Hill Road
 Summerdale, PA 17093
 (717) 732-3636

holds it in readiness. After the joint is heated, the tip of the tool rapidly is moved on top of the joint, and the trigger activated. An internal spring expands the chamber size, causing a vacuum which sucks up some of the molten solder. Operation of the Edsyn Snortini, shown here, can be done with one hand. One picture shows a thumb about to slide the cocking lever, and the other shows Snortini ready for action. The trigger can be released either by thumb or finger, according to how it is held.



solder remains. This prevents pulling out all leads of a transistor (for example) at the same time. Grasp the component lead with a small pair of long-nose pliers, and shake it gently in all four directions. Listen as you do this; usually a faint popping sound will indicate the solder bond has broken. When the lead can be moved easily, it is ready for removal.

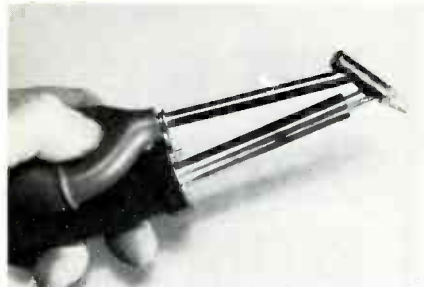

Tip 9 Consell has three sizes of desoldering vacuum devices, the MAXI, MINI, and the MINI-MINI (smallest). These precision tools are all-metal, except for a few plastic parts, and the machined Teflon tip. Solder inside the tip is expelled by an internal rod, during the cocking operation (most vacuum tools remove the solder this way).

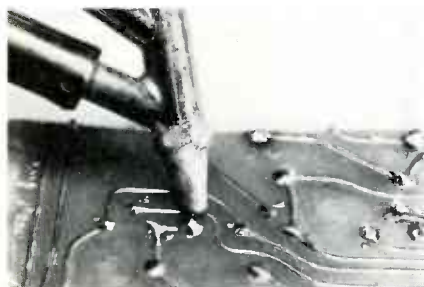

Tip 8 The Model 510 Endeco iron (from Enterprise Development) has several conveniences. A switch permits idling at about 20 watts, or full heat of 40 watts, with a light in the handle that changes brightness in step with the wattage. It has a vacuum device built on. The bulb is squeezed by a thumb, then the hollow tip is placed over the joint. After a short time for the solder to melt, the thumb pressure is removed and the solder is pulled up inside the bulb. The advantage is that the vacuum tip always is in correct position.



Tip 10 Several sizes of vacuum tools are available from Edsyn, under the name SOLDAPULLIT. Also, Edsyn has a helpful training manual combined with product information. Many things about correct soldering and desoldering are explained.

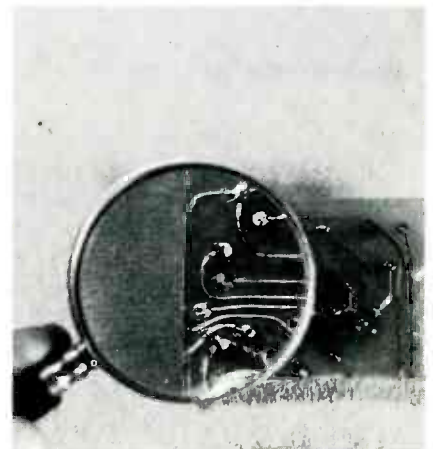

Tip 12 Unless you have exceptionally-good eyesight, you should have several kinds of magnifying glasses. The days of soldering every joint on a board "just in case" are over. *Find the bad joint before soldering!* A joint that did not tin properly at the factory might not tin right for you, either. Check it before and after you solder it. The round reading glass does fine, but get a good one; not all are sharp. All simple magnifiers have blue fringing at the edges, but get a kind with less. The glass on a frame has a 7-watt bulb for illumination, and the lens is wide enough to see through with both eyes. Larger units often have a circular fluorescent lamp.

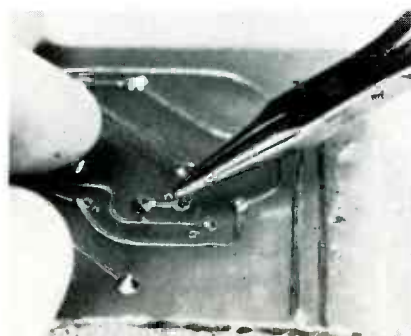

Tip 11 Often, following removal of all the solder possible, a tiny bit of

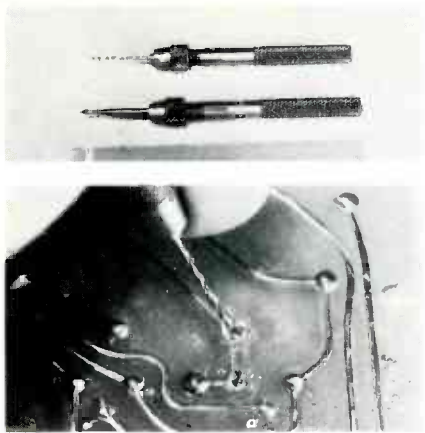

Tip 13 It's frustrating to have all the holes appear to be open, when you're ready to install a replacement transistor, and then have one or more leads bend instead of entering the hole. An excellent solution for this problem is to use a tiny set of drills and burrs, with two finger-type handles. These tools are made by Total Technology, Incorporated (TTI). Two sizes of drills, and two sizes of reamers are included. Old solder can be drilled out of holes within a few seconds. Or, a new hole can be drilled in a board, when required. I highly recommend this "Circuit Repair Kit".



Tip 14 Don't junk your "old standby" soldering gun. Keep it for service calls, and for heavier soldering on tube receivers. But the tip is just too hot for circuit boards.

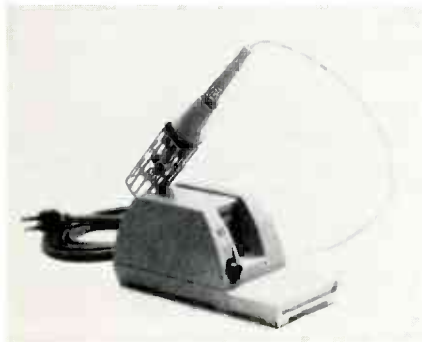

Tip 15 A soldering iron that does not have automatic heat control should have a rating of 24 to 30 watts. Higher heat might damage

circuit boards, and lower heat could produce "cold" joints. Of course, you could use an iron with a higher wattage and reduce the voltage with a variable transformer. Unfortunately, we tend to forget to change the adjustment, or think it too much trouble.

A thermostatically-controlled iron, such as the Ungarmatic Model 50T7 soldering system, solves the problems. The unit cycles on and off (about .5 ampere when on), and the element operates from 24 volts, for isolation. Only about 30 seconds are required to melt solder on the tip, and fairly-large joints can be soldered, because of the reserve heat.

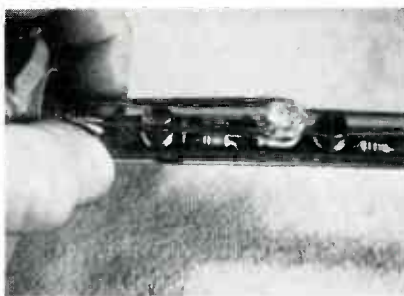

Tip 16 The LONER soldering iron and IDLE REST holder (from Edsyn) have some interesting features. An electronic closed-loop circuit controls the temperature, drawing about .6 ampere when the element is on (indicated by a neon lamp), and *the entire circuit is displayed through the clear plastic of the handle*. A fuse, an SCR used as a switch, an IC differential amplifier, and resistors are visible. A variable-heat control is adjustable from the outside. The iron holder has thermal insulation, allowing the iron to idle at 9 watts when in the holder. Two locking pins are provided; one allows the barrel to lie flat for moving, and the other locks the iron in the barrel. Under the base are two spools of solder, with pegs to hold the ends or to permit breaking the solder, and a wiping sponge is included.

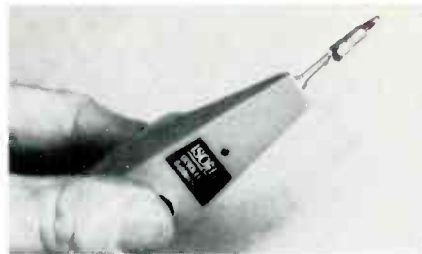

Tip 17 Irons operated from internal Ni-Cad batteries have the advantage of not requiring a nearby source of AC power. Also, FET's, and other sensitive devices, can be soldered safely, because no AC power is connected to the iron. Such an iron is the ISO-TIP built by Wahl. One model has a stand with a fast-charger, giving a full change in a few hours.

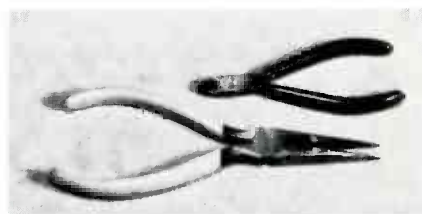

Tip 18 Use small tools when you work with small components. The diagonal cutter shown here is a small size, compared to the "normal"-size long-nose pliers. Regardless of the size, make sure the teeth of pliers meet correctly, allowing dikes to cut paper, and long noses to bend wire without sliding. Good tools save time, and contribute to professional workmanship.

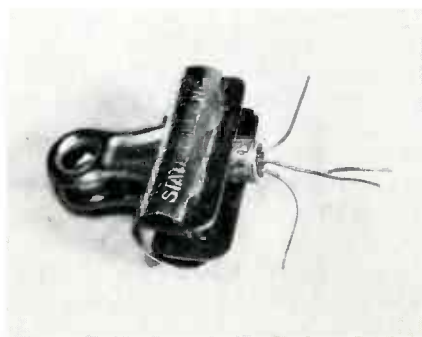



Tip 19 Keep on hand a variety of small tools to help with small components. A split-end soldering tool can move wire leads, bend them to shape, or unwind a wrapped connection. A clip-board clip can hold parts in position for soldering, or act as a heat sink for a diode or transistor during soldering. Tweezers sometimes can work in areas too small for long-nose pliers. Tighten a rubber band around the center to enable the tweezers to hold objects without requiring a hand.



Tip 20 Remember that the best solder for electronic work is 60% tin, and 40% lead, with rosin flux (*never* use acid flux). Neither of those metals has any great strength. Therefore, don't depend on solder alone to hold any joint. Resistor or capacitor leads should be inserted into and through the holes of the circuit board. If you are forced into making an exception, tin the wire before it's laid against the joint, and solder with a hot iron and lots of solder. In the photo, the printed wire on the left has a blob of solder applied to bridge the crack. It is likely to break again at, or near,

the same point. A better way is to lay a pre-tinned length of wire on top of the board wire and solder it there to add strength (as shown at the right).



Tip 21 This transistor removal can't be considered a success. One hole is plugged with solder, one is okay, and the third (at top) has had the copper foil lifted from the board by excessive temperature of the iron tip. If the loose foil merely is soldered to the lead of the new transistor, there's a good chance of more trouble later on. It's better to remove the loose piece of foil, and substitute a piece of bus wire.



Tip 22 The rough solder in the center is one variety of "cold joint". It might have been caused by movement while the solder was cooling from a liquid to a solid. Insufficient flux, or not enough heat at the iron tip, also can give that appearance. Beware of solder that looks gray, wrinkled, or grainy. *Do not make a joint by applying the solder to the iron tip, and then transferring it to the joint!* Most of the flux might be used up, resulting in a cold joint. **Don't** merely add fresh solder to a bad joint; instead, remove most of the old solder and start over.



Tip 23 Is it possible to repeatedly remove and re-install a soldered-in component without board or component damage? Yes, it can be done. I lost count of how many unsolderings and solderings these three joints endured, but it was at least 12 separate operations. Yet the board is in perfect shape. It was done as suggested in this article: the iron had a small tip, and was thermostatically controlled at 700 degrees. A vacuum-type tool was used to remove most of the solder, the leads were loosened from the last remains of the solder by moving them with long-nose pliers. This allowed the old transistor to be lifted easily. After the transistor was out, the holes were opened completely by use of the TTI drills. The new transistor slid into the open holes without any forcing, and the leads were soldered with a controlled-temperature iron.

For good soldering, have the iron tip at the correct temperature (neither too hot, nor too cold), apply the solder *between* the joint and the tip, using sufficient solder to generously cover the wire, and remove the iron tip just after the joint has become properly fluid. Beyond a certain time, the flux is used up, and the possibility of damage increases. A perfect soldered joint should be smooth and shiny. By not soldering for too long, I have never ruined a transistor by excessive soldering heat.

Comments

I have checked all of the tools mentioned here, and I like them. This does not imply that similar products by other manufacturers are in any way less desirable. Weller-Xcelite, for example, makes all types of excellent irons, including battery-operated and thermostatically-controlled models. However, most of the ones pictured were sent to us for evaluation, plus a few that I own. □

bookreview

HI-FI Stereo Servicing Guide, Second Edition

Author: Robert G. Middleton
Publisher: Howard W. Sams & Co., Inc., 4300 West 62nd Street, Indianapolis, Indiana 46268
Size: 104 pages, book number 21075
Price: \$4.50 softbound (\$5.40 in Canada)

This second edition covers all components of the hi-fi stereo system (except record players and tape recorders, covered in other volumes by the author). The book is divided according to sections in the hi-fi system and is further divided according to symptoms. The text is illustrated with appropriate schematics and photographs. The following topics are given extensive treatment: AM tuner troubles, FM tuner troubles, stereo multiplex troubleshooting, introduction to audio amplification, servicing audio amplifiers, installing hi-fi speakers, system evaluation, and trouble localization. It has been brought up-to-date by the addition of such topics as the use of integrated circuits, digital tuning indicators, digital frequency synthesizers, and quadriphonic sound.

Zenith Color TV Servicing Manual-Volume 4

Author: Robert Goodman
Publisher: Tab Books, Blue Ridge Summit, Pennsylvania 17214
Size: 196 pages, book number 838
Price: \$8.95 hardbound, \$5.95 paperback

Servicing information of Volume 4 covers 17 chassis from 19EC13 through 25GC45 of the E, F and G lines for the 1974-through-1975 years. The service data is complete, including setup and alignment instructions, adjustments, field-modification changes, trouble histories, waveform photos, and parts lists. One chapter covers servicing the new varactor-tuning circuits, another is devoted to Zenith's all-solid-state Space Command remote controls. Author Goodman has written one chapter about solid-state troubleshooting methods that differ from those for tubes. The practical case histories are illustrated with waveforms, partial schematics, and drawings to help readers save time when doing similar repairs.

FOR HOME AND INDUSTRY
EDSYN
 PRODUCTS

WORLD'S MOST PRACTICAL SOLDER HANDLING TOOLS
**SOLDERING +
 DESOLDERING +
 RESOLDERING =**
SOLDER Ability ELEMENTARY TO ELITE

UL UL

MOST PRODUCTS COVERED BY U.S. AND FOREIGN PATENTS AND PENDING APPLICATIONS

EDSYN 144 PAGE TRAINING MANUAL
 15824 ARMINTA ST., VAN NUYS, CALIF. 91406
 24 HR. PHONES Local (213) 989-2324 L. A. (213) 873-5115
 CABLE: EDSYNEX VAN TELEX 85-1469

NEW! OVER 1,000 ILLUSTRATIONS

FANOVISION

For More Details Circle (19) on Reply Card

What
 would
 you
 like
 to
 read
 in
 ES?
 Send
 in
 your
 ideas.

need belts?

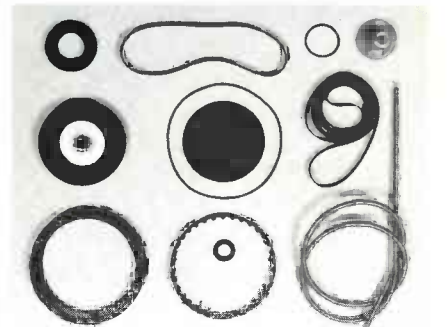

Standard and special belts and tires ready for immediate shipment — fit over 3,000 new and obsolete makes of tape recorders, projectors, dictating machines, video recorders, and turntables. Simplified cross reference system makes ordering easy with **one day service** on most items. Drive tires, wheels, phono idlers also listed. Call or write for **free catalog**. DEALER INQUIRIES INVITED.

PROJECTOR-RECORDER BELT CORP.

319 Whitewater St., Whitewater, WI 53190 — (414) 473-2151

For More Details Circle (20) on Reply Card



CASTLE Timesavers
... for the Professional

SUBBER® signal circuit analyzing Instruments

* Made in USA.

Mark V



Mark IV-CUV



Mark IV-C

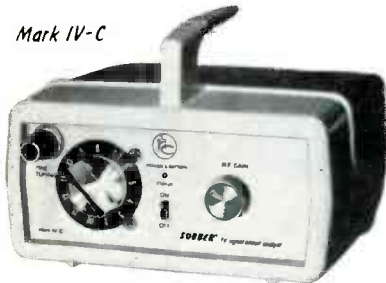

Ask your electronic distributor for them
... or write for more details.

CASTLE ELECTRONICS, INC.

5701 N. Western Ave., Chicago, Ill. 60645

• Ph. (312) 728-1800

For More Details Circle (21) on Reply Card

FREE ALARM CATALOG

Huge selection of burglar & fire systems, supplies. Motion detectors, infrared beams, controls, door switches, bells, sirens. 500 items, 99 pp. packed with technical details, notes.

(Outside U.S., send \$1.00.)

mountain west alarm

4215 n. 16th st., phoenix, az. 85016

For More Details Circle (24) on Reply Card

APPLIANCE REPAIR BOOKS

Written in easy-to-understand language by experts with illustrations & diagrams. Acclaimed by instructors & professionals. How to diagnose & repair air conditioners, refrigerators, vacuum cleaners, ranges, washers, dryers, steam irons, portable kitchen appliances, water heaters; plus how to set up a shop, using test instruments and more. Only \$2.65 to \$4.90 each!

SEND FOR FREE DESCRIPTIVE PRICE LIST

C & N, DEPT. ES, 5841 MONTROSE, CHICAGO 60634

For More Details Circle (28) on Reply Card

productreport

These features supplied by the manufacturers are listed at no-charge to them as a service to our readers. If you want factory bulletins, circle the corresponding number on the Reply Card and mail it to us.

Supplement to ECG Guide

GTE Sylvania has published an 18-page illustrated supplement to its 1975 ECG semiconductor replacement guide and catalog, adding 8,000 industry part numbers cross-referenced to the company's line of solid-state devices.

The booklet contains an index/product list, technical data, and a replacement directory which itemizes additions, deletions, and changes in the Sylvania ECG semiconductor line. It cross-references a total of 114,000 domestic and imported devices.

The guide is priced at \$2.95; the supplement is 35 cents.

For More Details Circle (35) on Reply Card

Flashlight-Defense Weapon

A combination flashlight and defense weapon, from Mountain West Alarm Supply guards against assault, robbery, or animal attack.

The Guardian Personal Protection Flashlight dispenses a stream of non-lethal "Capsaicin", (a pepper solution), directly where the light beam is aimed, up to 12 feet. The repellent can be released with the light on or off.

The C13 uses two penlight batteries and is equipped with a standard PR-2 flashlight bulb and chemical cartridge; it sells for \$10.15.

For More Details Circle (36) on Reply Card

In Dash CB And AM/FM-stereo

Panasonic Auto Products has entered the CB market with an AM/FM-stereo pushbutton unit that has a compact chassis for in-dash installation.

Model CR-B1717 covers 23 channels and has a selector switch with channel indicator, RF output power of 3.5 watts, a P/S meter, a variable-squelch control, and Delta tuning. The unit also includes a standby monitor that permits reception on CB calls while listening to AM or FM broadcasts, an automatic noise limiter, and a detachable microphone.

Other features are an AM/FM slide-bar selector switch, two-way balance control, and a stereo indicator light.

For More Details Circle (37) on Reply Card

I.C.C.—NEW-BOXED

<input type="checkbox"/> 1V2	5 for \$3.20	<input type="checkbox"/> 6HO5	5 for \$ 6.75
<input type="checkbox"/> 2AV2	5 for \$4.20	<input type="checkbox"/> 6HV5	5 for \$11.80
<input type="checkbox"/> 3A3	5 for \$5.35	<input type="checkbox"/> 6JC6	5 for \$ 5.95
<input type="checkbox"/> 3AT2	5 for \$5.20	<input type="checkbox"/> 6JE6	5 for \$11.15
<input type="checkbox"/> 3GK5	5 for \$5.15	<input type="checkbox"/> 6JS6	5 for \$ 9.90
<input type="checkbox"/> 3HA5	5 for \$5.10	<input type="checkbox"/> 6JU8	5 for \$ 5.90
<input type="checkbox"/> 3HM5	5 for \$5.10	<input type="checkbox"/> 6KA8	5 for \$ 6.50
<input type="checkbox"/> 5GH8	5 for \$6.25	<input type="checkbox"/> 6KE8	5 for \$ 8.15
<input type="checkbox"/> 6BK4	5 for \$9.95	<input type="checkbox"/> 6KT8	5 for \$ 7.25
<input type="checkbox"/> 6CG3	5 for \$5.25	<input type="checkbox"/> 6KZ8	5 for \$ 5.25
<input type="checkbox"/> 6CJ3	5 for \$5.00	<input type="checkbox"/> 6LB6	5 for \$10.75
<input type="checkbox"/> 6DW4	5 for \$5.00	<input type="checkbox"/> 6LQ6	5 for \$11.15
<input type="checkbox"/> 6EA8	5 for \$5.25	<input type="checkbox"/> 8FQ7	5 for \$ 4.05
<input type="checkbox"/> 6EH7	5 for \$5.10	<input type="checkbox"/> 12BY7	5 for \$ 7.00
<input type="checkbox"/> 6EJ7	5 for \$4.75	<input type="checkbox"/> 12GN7	5 for \$ 7.40
<input type="checkbox"/> 6F07	5 for \$4.05	<input type="checkbox"/> 17JZ8	5 for \$ 4.75
<input type="checkbox"/> 6GF7	5 for \$7.05	<input type="checkbox"/> 23Z9	5 for \$ 6.35
<input type="checkbox"/> 6GH8	5 for \$4.20	<input type="checkbox"/> 33GY7	5 for \$ 8.05
<input type="checkbox"/> 6GJ7	5 for \$3.70	<input type="checkbox"/> 36MC6	5 for \$11.40
<input type="checkbox"/> 6GU7	5 for \$5.55	<input type="checkbox"/> 38HE7	5 for \$ 9.75
<input type="checkbox"/> 6HA5	5 for \$5.10	<input type="checkbox"/> 38HK7	5 for \$ 9.55
<input type="checkbox"/> 100—2.5 Amp 1000 PIV DIODES		\$9.95
<input type="checkbox"/> 10—15KV FOCUS RECTIFIERS		\$4.50
<input type="checkbox"/> 20—1N34A CRYSTAL DIODES		\$2.00
<input type="checkbox"/> 4—3.58 Mhz Color Crystals		\$2.49
<input type="checkbox"/> RCA DAMPER DIODES REPL 135932		\$2.98 P.
<input type="checkbox"/> ZEN. VOLT TRIPLER 212-109		\$3.95 Ea.

ZENITH TUNERS NEW (TUBES)

<input type="checkbox"/> 175-1118	\$4.50 ea.
<input type="checkbox"/> 175-1120	\$4.50 Ea.
<input type="checkbox"/> 175-1122	\$4.50 Ea.
<input type="checkbox"/> 175-1164	\$4.50 Ea.

REPL. DIAMOND NEEDLES

SHURE

N-3D—N44—N75—N91 \$2.95 Ea.

PICKERING

V-15 GREY—V-15 ORANGE \$2.95 Ea.

COLOR IC CHIPS

<input type="checkbox"/> REPL. ZEN. 221-42	4 for \$5.00
<input type="checkbox"/> REPL. ZEN. 221-46—51	4 for \$5.00
<input type="checkbox"/> REPL. ZEN. 221-62	4 for \$5.00
<input type="checkbox"/> 30 W Pencil Soid. Iron	\$2.19 Ea.
<input type="checkbox"/> 2—2 Set Couplers 300 Ohm	\$3.00
<input type="checkbox"/> 2-4 Set Couplers 300 Ohm	\$4.50
<input type="checkbox"/> 100 Asst'd Springs	\$1.79
<input type="checkbox"/> 50 Asst'd. WW Resistors	\$2.69
<input type="checkbox"/> 50 Asst'd. Controls	\$2.00
<input type="checkbox"/> 200 Asst'd. Resistors (OUTLEADS)	\$1.89
<input type="checkbox"/> 75-300 Ohm Match. Xfmr.	6 for \$5.00
<input type="checkbox"/> 6 Asst'd. UHF TUNERS	\$3.00
<input type="checkbox"/> 70%-COLOR YOKE (21" CRT)	\$3.95
<input type="checkbox"/> 8" SPEAKER (W/TWEETER)	\$3.00
<input type="checkbox"/> 3-C60-IRISH CASSETTE TAPES	\$1.49
<input type="checkbox"/> 25 Asst'd SLIDE SWITCHES	\$2.00
<input type="checkbox"/> 66 MEG. HV RES. (IRC)	4 for \$2.00
<input type="checkbox"/> 25 Asst'd. Filter CANS	\$3.95
<input type="checkbox"/> 25 Asst'd. Filters (AXIAL)	\$3.95
<input type="checkbox"/> 50 Asst'd Filters (TRANS. WORK)	\$4.95
<input type="checkbox"/> Univ. CASSETTE MICROPHONE	\$2.19 Ea.
<input type="checkbox"/> 70% COLOR CRT BOOSTERS	3 for \$11.50
<input type="checkbox"/> 90% COLOR CRT BOOSTERS	3 for \$12.50
<input type="checkbox"/> 10—RCA PHONO PLUGS	\$1.19
<input type="checkbox"/> 4—ASST'D STEREO CARTRIDGES	\$4.95
<input type="checkbox"/> MONO TONEARM	\$1.69
<input type="checkbox"/> 70% CONVERG. ASSEMBLY	\$1.00
<input type="checkbox"/> 90% CONVERG. ASSEMBLY	\$1.00
<input type="checkbox"/> SHUNT REG. HOODS-(6JE6 etc.)	2 for \$1.19
<input type="checkbox"/> 25 Asst'd. PLATE CAPS-(6JE-6D06)	\$1.00
<input type="checkbox"/> 6 Asst'd FOCUS SOCKETS	\$1.19
<input type="checkbox"/> 6—HV ANODE LEADS LARGE CUP	\$2.49
<input type="checkbox"/> 5—CRT HARNESS COLOR 19"-25" CRT	\$1.19

SEND FOR FREE CATALOG

TUBES UP TO 80% off
MINIMUM ORDER \$35.00

Orders under \$35.00—\$2.00 shipping & handling

SEND CHECK OR M.O.

TV TECH SPECIALS

P.O. BOX 603

KINGS PARK, L.I., NEW YORK 11754

PHONE 516-269-0805

For More Details Circle (22) on Reply Card

ELECTRONIC SERVICING

test equipment report

These features supplied by the manufacturers are listed at no-charge to them as a service to our readers. If you want factory bulletins, circle the corresponding number on the Reply Card and mail it to us.

Frequency Counters

Four new autoranging frequency counters, the 380 Series, have been added to the test instrument line of **Hickok Electrical Instrument Company**. All units feature large, bright 0.3" LED seven-digit displays and fast update of 1.1 seconds in AUTO mode below 10 MHz, and 0.5 second update in SPEED READ mode or above 10 MHz.

Model 380 is the basic autoranging counter with 80 MHz range. The complete frequency is displayed with 1 Hz resolution to 10 MHz. Above 10 MHz the decimal point shifts automatically and all digits, (except the least-significant digit), are displayed. Standard time base stability is 10 ppm. Price, \$259.

Model 380X provides the same features as the Model 380 but has a high-stability Temperature Compensated Crystal Oscillator (TCXO) time base with 1 ppm stability. Price, \$385.

Model 385 is the autoranging UHF frequency counter for measuring frequencies to 512 MHz. Because the UHF prescaler is built-in, the decimal point is placed properly on the display over the entire range. The time base stability is 10 ppm. Price, \$499.

Model 385X provides the same features as Model 385 but incorporates the high-stability TCXO time base with 1 ppm stability. This model meets FCC requirements for almost all communications frequencies. Price, \$625.

All units have provision for an external time base input on the rear panel.

For More Details Circle (38) on Reply Card

CB Servicing System

A new test instrument from **B&K Dynascan** is designed for fast, efficient servicing of CB radios. Model 1040 CB Servicemaster incorporates the functions of a peak-reading RF wattmeter, dummy load, audio wattmeter, audio generator, and distortion meter.

For tests, it is necessary to connect only a scope of 2-MHz (or wider) bandwidth, a stable signal generator,

and a frequency counter to the Model 1040 and the CB radio, which is connected to a DC power supply. All connections may be left unchanged, except for those to the radio under test.



It sequentially measures transmitter RF power output, and checks AM and SSB modulation, as well as antenna SWR. In the CB receiver section, it checks sensitivity (signal-to-noise ratio), audio output and distortion, frequency response, AGC, squelch and adjacent-channel rejection, all without modification or changes in the initial connections. Model 1040 also can be used as a troubleshooting device, by operating it from 12VDC vehicle power, while measuring mobile antenna systems.

Model 1040 is priced at \$250.

For More Details Circle (39) on Reply Card

Help!

Anytime you have a question about your subscription to *Electronic Servicing*, please include a mailing label to insure prompt service on your inquiry.

**AFFIX
LABEL
HERE**

Change of Address

If you're about to move, please let us know approximately four weeks before the move comes about. Simply affix your present label here, and carefully print the updated information below.

Please Help Us to Serve You Better

Electronic Servicing
1014 Wyandotte Street
Kansas City, Mo. 64105

Name _____
(Please Print)
Employer _____
Address _____
City _____ State _____ Zip _____

BOOST your TV service profits with the NEW Heathkit CRT Tester/ Rejuvenator

The NEW IT-5230 CRT tester/rejuvenator adds versatility to your service bench. You can check, "clean" and rejuvenate virtually every TV picture tube available including NEW IN-LINE GUN CRT's without adaptors! It's portable, practical and priced right...you NEED it on your bench!

Kit IT-5230, Shpg. wt. 10 lbs. 89.95

Assembled ST-5230 140.00

PHONE YOUR ORDER NOW!

Call (616) 982-3411

Send for FREE Catalog Today!



TE-333A



Heath Company, Dept. 25-17, Benton Harbor, Michigan 49022

For More Details Circle (23) on Reply Card

(Continued from page 10)

Wanted: Information on the availability of 16 mm training films in electronics. Send information and prices.

Henson TV service
P.O. Box 700
Carrollton, Texas 75006

Needed: Schematic and/or deflection board (#AM-B-332) for Longines Symphonette Model LTV-77A

b-w TV, or information as to where they can be purchased. Call collect 804/321-2425.

John Branch
3000 Woodrow Avenue
Richmond, Virginia 23222

For Sale: New B&K Model 747B dyna-jet tube tester, \$259; new B&K Model 466 CRT tester and rejuvenator with adapters CR62, CR63, CR64, CR57, CR65, CR67, \$149; and new B&K Model 1246 deluxe digital IC color generator,

\$149.

Mario W. Zupan
P.O. Box 302
Mineola, New York 11501

Needed: Old University speaker #6201. With or without enclosure. Was used in custom hi-fi systems in the 1950's.

Abbott L. Thompson
6327-171st Avenue S.E.
Snohomish, Wash. 98290

Needed: Supreme radio manual #1. Schmidt's TV and Radio Highway 281 N.W. Jamestown, N.D. 58401

Needed: Photofact AR-67 manual, or copy of schematic for Chevy (Delco) Model 91 BT 411 tape deck. Will buy, or copy and return.

Al Potter
2 Buttonwood Drive
Parlin, New Jersey 08859

For Sale: Rider's TV manuals 3-14, with schematics, TV manuals 1952-1961, and many other radio books and manuals from 20 years ago, all for \$50 FOB.

Bob Kramer
539 S. State Street
Aurora, Illinois 60505

Needed: Manual or schematic for DeVry transistorized automotive analyzer. Will buy, or copy and return.

Stanley G. Boler
116 S. Washington Street
Knightstown, Indiana 46148

For Sale: Triplet Model 6028 digital multimeter, like new. Complete with owner's manual, schematic, parts list, probes, and leather carrying case for \$100. Will pay shipping. New price was \$275.

John McNevin
60-93 Wilson Way
Milpitas, California 95035

Needed: Movable cover (lid) part of cabinet or complete cabinet, and telescoping antenna for Zenith transoceanic radio Model R600, chassis 6R41.

Robert Allen
606 Patterson Avenue
Willow Grove, Pa. 19090

LECTROTECH 50 MHz FREQUENCY COUNTER

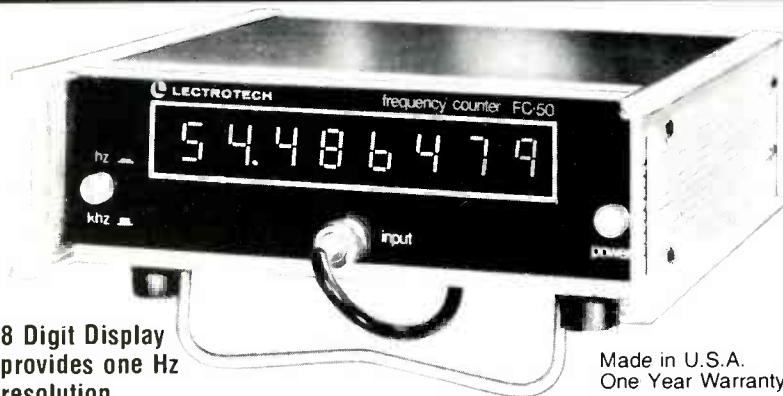

- 8 Digit Display provides one Hz resolution
- 50 MHz Guaranteed

Made in U.S.A.
One Year Warranty

FC-50 Frequency Counter is the ideal instrument for measuring frequency and adjusting CB, Business Band, Marine and other radio receivers and transmitters up to 50 MHz including scanner crystal frequencies.

- 8 Digit Display eliminates the need for overflow, no memorizing of first 2 most significant digits.
- Operates from both AC and DC power sources. FC-50 is capable of operation from 12 volt DC source such as auto battery with optional cigar lighter attachment. Permits CB frequency checks directly in vehicle. (Other accessories available for complete CB servicing)
- New LSI (Large Scale Integration) frequency counter circuitry provides precise accuracy in servicing and greater reliability at lower cost to you

\$19950

... net only

SPECIFICATIONS:

Frequency Range: 10 Hz to 50 MHz. **Number of Digits:** 8 full digit display. **Digit Size:** 0.5 inch. **Resolution:** 1 second gate—1 Hz. 1 m-sec gate—1 KHz. **Gate Times:** 1 second and 1 milli second. **Sensitivity:** 30 mv RMS to 40 MHz. 50 mv RMS 40 to 50 MHz. **Input Impedance:** 1 megohm and 30 pf. **Connector:** Front panel BNC. **Input Protection:** Max Input, DC and AC Peak. Frequency Range—10 Hz to 100 KHz./250 Volts, 100 KHz to 5 MHz./100 Volts, 5 MHz to 50 MHz./50 Volts. **Line Voltage Stability:** Better than ± 1 PPM after 30 min warmup. **Time Base Setability:** ± 1 Hz. **Temperature Stability:** Better than ± 10 PPM from 0-50 Deg. C. **Power Requirements:** 105-130 V. 60 Hz. 15 Watts max., or operation from 12 volt car battery with optional cigar lighter attachment cord. **Size:** 2.5 x 8.25 x 8.25". **Weight:** 4 lbs. **Handle:** Combination carrying handle and tilt stand.

See your distributor or write:



LECTROTECH, INC.

5810 N. Western Ave., Chicago, Illinois 60659 (312) 769-6262

For More Details Circle (25) on Reply Card

ADMIRAL Chassis T2L6-1A/-2A, T3L6-1A/-2A	1573-1
CURTIS MATHES Chassis CMC-55	1573-2
GENERAL ELECTRIC Chassis 13YA (1976 PROD.)	1579-1
HITACHI T-31	1579-2
JC PENNEY 685-2211UA/14UA, 2211UA/14UA	1576-1
MGA CS-172C	1569-1
PANASONIC CT-974/C (Ch.ETA-12D)	1577-2
QUASAR Chassis 17TS-/Y17TS-/19TS-/C19TS-/ Y19TS-, Y19TS-/YC19TS-953	1575-1
RCA Chassis CTC81A	1572-2
SEARS 562.51161500	1566-1
SONY Chassis SCC-63C-E	1565-2
SYLVANIA Chassis A19-3, A22-2	1574-2
TEKNIKA CI-3012	1578-2
WARDS AIRLINE GEN-12345A	1562-1
ZENITH Chassis 19GC38, 19GC38Z	1562-2

**Protect Your Heart
REDUCE IF OVERWEIGHT**

Give Heart Fund

WE'RE ON TRIAL

But, you're the judge.

To introduce you to Dana's quality tested Danameter® 2000A we're offering you a **thirty day free trial** period to use our DVM and judge its new reliable features. If it doesn't fit your needs, return it...that's right, return it. Why make such a fantastic offer? Just look at what the Danameter 2000A offers!

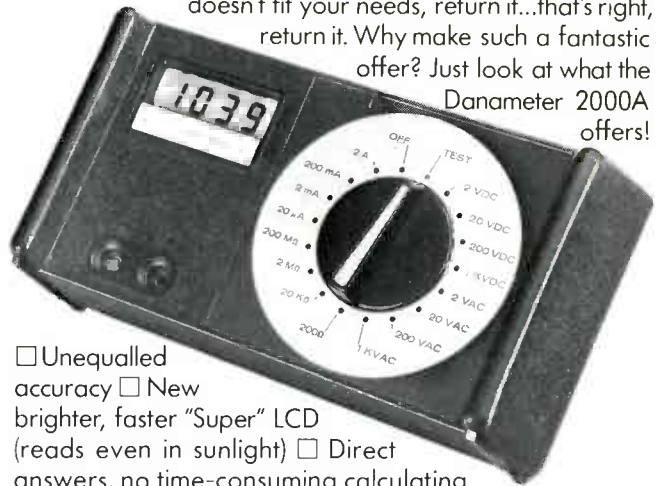

- Unequalled accuracy
 - New brighter, faster "Super" LCD (reads even in sunlight)
 - Direct answers, no time-consuming calculating
 - 1 full year battery life
 - LSI-CMOS circuitry
- And best of all...it costs only \$199.50!

Send for more details now...put us on trial. The new Danameter 2000A will come out ahead! For immediate action, call Cliff Hamilton at 714/833-1234.



Others measure by us.

For More Details Circle (26) on Reply Card

The 5 SECOND TUNER RESTORER

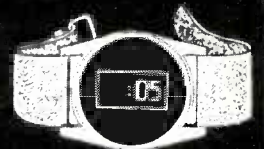

**CLEANS!
LUBRICATES!
POLISHES!**

Spray TUN-O-POWER on tuner contacts, rotate the tuner and *within 5 seconds* you get beautiful color pictures on all channels. It's a minor miracle!

TUN-O-POWER is the most powerful polisher and lubricant ever developed. It works so well, you use a lot less. You can spray twice as many tuners with TUN-O-POWER as you can with an ordinary cleaner/lubricant.

What's more, TUN-O-POWER lubricant lasts for months longer than ordinary sprays. Detent action stays smooth as silk so you never have to worry about callbacks.

**CHEMTRONICS
INCORPORATED**

45 HOFFMAN AVE. HAUPPAUGE, N.Y. 11787 • (516) 582-3322

Our business is improving yours!



For More Details Circle (27) on Reply Card

The MARKETPLACE

This classified section is available to electronic technicians and owners or managers of service shops who have for sale surplus supplies and equipment or who are seeking employment or recruiting employees.

Advertising rates in the Classified Section are 35 cents per word, each insertion, and must be accompanied by cash to insure publication.

Each initial or abbreviation counts a full word.

Minimum classified charge \$3.00.

For ads on which replies are sent to us for forwarding (blind ads), there is an additional charge of \$3.00 per insertion to cover department number, processing of replies, and mailing costs.

Classified columns are not open to advertising of any products regularly produced by manufacturers unless used and no longer owned by the manufacturer or a distributor.

FOR SALE

ADVERTISING PACKAGE FOR TV service shops. Inexpensive eye catching ads contain personal message from you-build customer confidence. Keeps your name before the public weekly. **PROVEN RESULTS.** Thirty ads with instructions \$19.95. Sample \$1.00 refundable. TV TIPS, 430 South Jefferson, Lebanon, Mo. 65536. 11-75-8t

NEW Canadian Magazine "Electronics Workshop". \$5.00 yearly. Sample \$1.00. Ethko, Box 741, Montreal "A" Canada. 10-75-12t

CONVERT any transistorized T.V. tuner to a tuner substituter. Plans \$2.00. New accelerated Radio & T.V. course. **RADIO TELEVISION TRAINING**, Box 279, ES-56, Syracuse, N.Y. 13206. 8-75-tf

TEKTRONIX SCOPES—Hewlett-Packard generators, other test and electronic equipment parts, tubes, "ham" supplies, surplus, and older parts. **ELECTRONIC SPECIALTIES**, 1659 W. Wetmore, Tucson, Az. 85705. (602) 887-9729. 1-76-12t

COLOR-BAR Generator 16 patterns, pocket size. CMOS-LS1 chip, one transistor. Complete plans \$5.00. Workshop, Box 393, Bethpage, N.Y. 11714. 4-76-2t

STOP... don't junk that television set. ASE manufacturers the world's most complete line of television picture tubes. No other company offers: Over 1700 types of television picture tubes. Most types immediate delivery. Transportation in the Midwest—paid, 1/2 transportation paid in other states. Tubes for Old or New Models. Complete line of both black & white and color. Full 2 year factory warranty. Lowest prices anywhere. Finest quality. Write today for more information. Allied Sales & Engineering, Inc., Dept. 27, Pimento, Ind. 47866, Telephone - 812-495-6555. 4-76-2t

\$9,000 ZENITH SERVICE INVENTORY—SAMS, Parts, Tubes, PA system, Test Equipment, call Kansas 913-367-4518. 5-76-1t

FOR SALE (CONT.)

SAMS CB RADIO PHOTOFACTS: Volumes 1 to 50, \$100 plus shipping. Robbins Electronics, Box 533, Cambridge, Maryland 21613, 301-228-7539. 5-76-1t

3,000 TUBES—latest to oldest. Randall's Radio & TV, Box 1167, Hobe Sound, Fla. 33455. 5-76-1t

TEST EQUIPMENT FOR SALE. Precise VTVM Model 909-Manual—\$35.00. Heathkit RF Signal Generator Model IG102—\$49.00. Heathkit Ignition Analyzer (IG20) Manuals—\$60.00. Heathkit Regulated Power Supply Model IP-32—\$60.00. Eico Model 250 AMP-VTVM—\$35.00. B & K TV Analyst Model 1076—\$250.00. Heathkit Audio Generator Model IG 72—\$45.00. Eldorado Frequency Counter Model 225—\$125.00. Precision Signal Generator Model E200C—\$75.00. B & K 415 Solid State Sweep Gen. (New)—\$375.00. Hickok (Large Scale) VTVM-Milli-Amp Meter—\$110.00. Tubes—70% off list. A. J. Martin, 527 Nantasket Ave., Hull, Mass. 02045. 5-76-1t

EDUCATION-INSTRUCTION

REPAIR TV TUNERS—High Earnings; Complete Course Details, 12 Repair Tricks, Many Plans, Two Lessons, all for \$2. Refundable. Frank Bocek, Box 3236 Enterprise, Redding, Calif. 96001. 4-76-4t

TV PROBLEMS??? Send symptoms with a copy of schematic and self-addressed stamped envelope and \$2.00, to Troubleshooter, Box 4553, Jowney, Ca. 90241. Results Guaranteed. 9-75-tf

BUSINESS OPPORTUNITY

CALIFORNIA BOUND? Take over established TV/HiFi shop on easy terms. Nets \$20,000+. Box 157, Palo Alto, 94301. (415) 327-5320. 3-76-3t

CONVERT black/white TV to color: experience not necessary. \$3.00 (refundable). Tayo Paul, 980 Greene Ave., Brooklyn, N.Y. 11221. 5-76-3t

ESTABLISHED TV SALES and Service business for sale: Test equipment, parts, Sams, Zenith and Quasar lines. Priced for quick sale. Woody's TV Clinic, Tucumcari, N.M. 88401. 5-76-1t

FOR SALE—on beautiful Galveston Island, Texas. One owner, established sales and service business for 24 years. Brick Bldg., with small apt. in rear. On commercial street. Write to P.O. Box 3482, Galveston, Texas 77552. 5-76-1t

TV SHOPS: Repair and update MATV systems with new patented method. \$200.00 day possible. Send resume and credit references: Melvin Cohen, Television Broadcast Engineer, May Company Building, 3651 Prospect Avenue, Riviera Beach, Fla. 33404. 5-76-5t

CAPE COD—Established TV Sales & Service business, center of town. Lock, stock & barrel. Reasonable. Write: O. Weatherwood, Box 921, Brewster, Ma. 02631. 5-76-2t

advertisers' index

American Technology Corporation	35
Arrow Fastener Co., Inc.	15
B & K Div., Dynascan Corp. ..	14
Blonder-Tongue Laboratories, Inc.	1
Broadcast Engineering	55
Bussmann Mfg. Div. McGraw-Edison	Cover 4
Castle Electronics, Inc.	54
Charous & Niebergall	54
Chemtronics Incorporated ..	57
Cost Effective Components ..	32
Dana Laboratories, Inc.	57
Edsyn, Inc.	53
Gem City Tuner	9
General Electric Company	Cover 3, 19
Heath Company	55
Lectrotech Inc.	56
Motorola Training Institute ..	49
Mountain West Alarm Supply Co.	54
Perma Power	32
Pomona Electronics	23
Precision Tuner Service	Cover 2
Projector-Recorder Belt Co. ..	53
RCA Distributor and Special Products	10, 11, 20, 21
Sperry Tech, Inc.	11
GTE Sylvania Consumer Renewal	3
TV Tech Specials	54
Tab Books	35
Tuner Service Corporation ...	5
Winegard	7

Fight Them All

Heart Attack, Stroke
High Blood Pressure
Rheumatic Fever

Help your Heart... Help your Heart Fund

American Heart Association

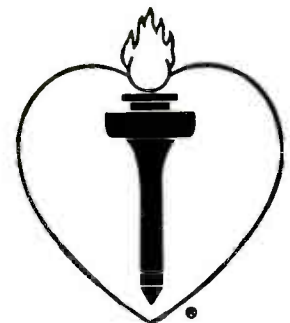

GE 19" diagonal MODULAR Solid State Set gets 91.7% serviceability rating from panel of NESDA members.



MODEL WYC7608WD

This high rating is another example of our continuing commitment to make your business easier.

It's based on a comprehensive checklist of items considered by NESDA (National Electronic Servicing Dealer Association) to be key factors in allowing service technicians to quickly and easily diagnose and repair a TV set.

According to Dick Glass, Executive Vice-President of NESDA, the panel found the overall serviceability of GE's 19" diagonal model WYC7608WD was "excellent".

The YC chassis is modular in design . . . Seven module subassemblies contain approximately 85% of all set components. But, like all General Electric modular chassis, it's designed to be serviced with or without modules. Its swing-away design provides easy access to module components and each module has abundant, clear markings.

We're making it our business to make your business easier.

 **performance**
TELEVISION

GENERAL  ELECTRIC

Buss® Fuses Specialize Too!

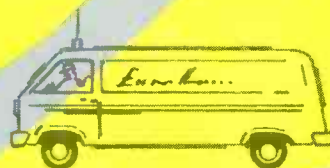

CB

EQUIPMENT

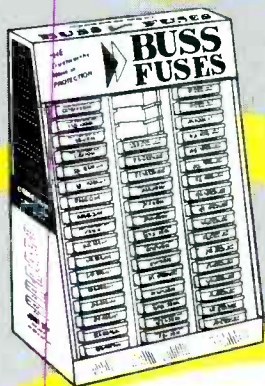

No. 240CB-3
Metal Display Stand



No. 80CB-1
Metal Display Stand

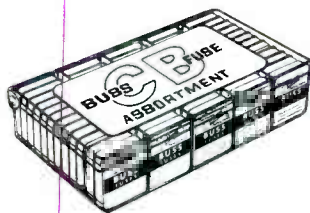

No. 240CB-4
Plastic Display Box

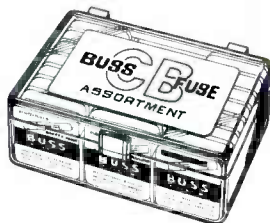

No. 80CB-2
Plastic Display Box

Now . . . four new BUSS fuse assortments exclusively designed with replacement fuses to service most Citizen-Band Radios — offering a whole new area of opportunities for increased profits.

Two assortments contain 48 — 5 in metal boxes (240 fuses). BUSS No. 240CB-3 fuse assortment comes in a handy metal display stand. BUSS No. 240CB-4 fuse assortment is packed in a compact plastic display box.

In addition, there are two fuse assortments containing 16 — 5 in metal boxes (80 fuses). BUSS No. 80CB-1 fuse assortment packed in a metal display stand and BUSS No. 80CB-2 fuse assortment in a plastic display box.

Both BUSS fuse assortments contain a careful selection of the most popular fuses used in CB radios.

CB dealers can now have the fuses they need in a neat complete package to service all their customers fuse needs.

For full fuse assortment details, write for BUSS Bulletin CBA.



BUSSMANN MANUFACTURING
a McGraw-Edison Company Division
St. Louis, Missouri 63107



For More Details Circle (1) on Reply Card